

# Simon XTi Installation Manual



P/N 466-2451 • REV A • 15MAR12

**Copyright** © 2012 UTC Fire & Security. All rights reserved.

**Trademarks and patents** The Simon XT<sub>i</sub> name and logo are trademarks of UTC Fire & Security.

GE and the GE monogram are trademarks of the General Electric Company and are under license to UTC Fire & Security, 9 Farm Springs Road, Farmington, CT 06034-4065, USA

Other trade names used in this document may be trademarks or registered trademarks of the manufacturers or vendors of the respective products.

**Manufacturer** UTC Fire & Security Americas Corporation, Inc.  
1275 Red Fox Rd., Arden Hills, MN 55112-6943, USA

**FCC compliance** This equipment has been tested and found to comply with the limits for a Class B digital device, pursuant to Part 15 of the FCC rules. These limits are designed to provide reasonable protection against harmful interference when the equipment is operated in a residential environment. This equipment generates, uses, and can radiate radio frequency energy and, if not installed and used in accordance with the instruction manual, may cause harmful interference to radio communications.

FCC Part 15 registration number: B4Z-910C-SIMON  
IC: 1175C-910CSIMO

Part 68. This equipment complies with Part 68 of the FCC rules and the requirements adopted by the ACTA.

FCC registration number: US: B4ZAK02B55910

Canada: 1175C-910SIXT  
Ringer Equivalence 0.2B  
Load Number 0.2

**Contact information** [www.utcfireandsecurity.com](http://www.utcfireandsecurity.com) or [www.interlogix.com](http://www.interlogix.com)

**Customer support** [www.interlogix.com/customer-support](http://www.interlogix.com/customer-support)

# Content

<b>Product overview .....</b>	<b>1</b>
System components.....	2
Standard panel .....	3
<b>Planning the installation .....</b>	<b>4</b>
Planning sensor types and locations.....	4
Cross-zoning .....	8
System configuration.....	9
<b>Installation .....</b>	<b>14</b>
Mounting .....	14
Connecting hardwired devices.....	15
Wiring a phone line to the panel.....	17
Wiring the power transformer .....	19
Resetting memory to factory defaults .....	21
Applying AC power .....	21
Designer template.....	22
<b>System configuration .....</b>	<b>25</b>
Status & Settings menu navigation .....	26
<b>Programming .....</b>	<b>35</b>
Access codes .....	35
Security.....	36
Phone numbers .....	39
Phone options .....	39
Sensors.....	41
Reporting .....	45
Timers .....	49
Touchpad options.....	51
System options .....	52
Siren options .....	53
Audio verification options .....	55
System tests.....	56
<b>Testing.....</b>	<b>57</b>
Sensor test.....	58
System download.....	62
Offsite phone operation.....	62
Two-way voice operation .....	63

Voice event notification .....	63
Cleaning the touch screen.....	64
Disposal.....	64
<b>Troubleshooting.....</b>	<b>65</b>
<b>Specifications .....</b>	<b>66</b>
<b>Sensor names .....</b>	<b>67</b>
<b>Simon XTi system quick reference .....</b>	<b>71</b>

# Product overview

This security system can be used as a fire warning system, an intrusion alarm system, an emergency notification system, or any combination of the three. The system has three types of components:

- Self-contained control panel
- Devices that report to the panel
- Devices that respond to commands from the panel

**Figure 1: Simon XTi system**

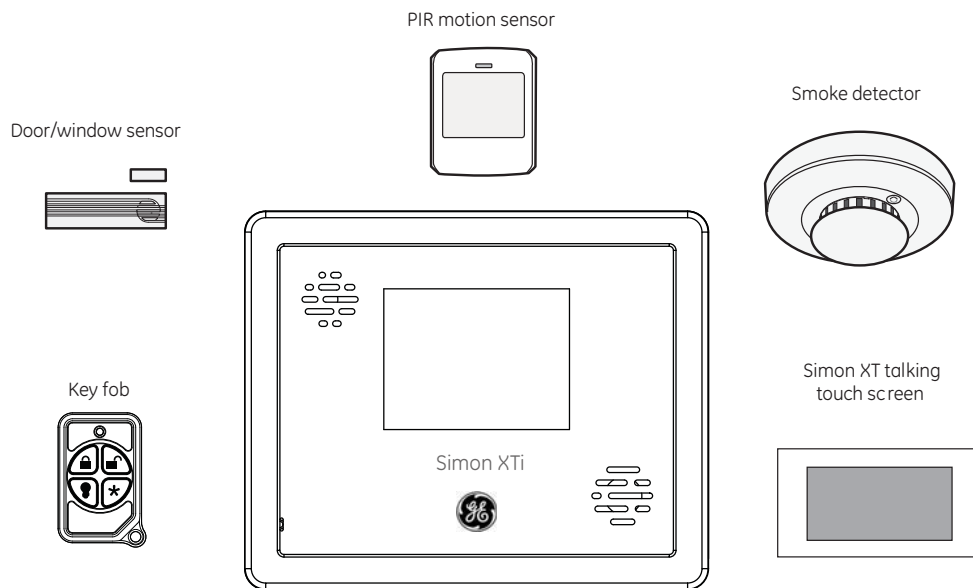

The self-contained panel provides the main processing unit for all system functions. It receives and responds to signals from wireless sensors and wireless touchpads throughout the premises. For monitored systems, the panel can be connected to the premises phone line for central monitoring station reporting.

You can program the panel onsite from the keypad or remotely using Enterprise Downloader software. See “Programming” on page 35 for complete onsite programming instructions.

## System components

The system can monitor up to 40 sensors and may use any of the devices listed in Table 1 below.

**Table 1: Supported devices**

Device	Description
Max Life Door/window sensor (60-362N-10-319.5)	For intrusion protection, install door/window sensors on all ground-floor doors and windows. At a minimum, install them in the following locations: <ul style="list-style-type: none"><li>• All easily accessible exterior doors and windows.</li><li>• Interior doors leading into the garage.</li><li>• Doors to areas containing valuables.</li></ul>
Indoor motion sensor (60-639 & 60-807-95)	Indoor motion sensors are ideal whenever it is not practical to install door/window sensors on every opening. Identify areas where an intruder is likely to walk through. Large areas in an open floor plan, downstairs family rooms, and hallways are typical locations for indoor motion sensors. For installations with pets, use the SAW Pet Immune PIR (60-807-95).
Smoke sensor (TX-6010-01-1)	Smoke sensors provide fire protection by causing an alarm to sound throughout the house. You can add smoke sensors near sleeping areas and on every floor of the house. Avoid areas that could have some smoke or exhaust such as attics, kitchens, above fireplaces, dusty locations, garages, and areas with temperature extremes. In these areas, you may want to install rate-of-rise sensors to detect extreme temperature changes. See the instructions packaged with the smoke sensor for complete placement information.
Glassbreak sensor (60-873-95)	Glassbreak sensors respond to shock waves of breaking glass. These sensors are designed to mount in the corner of windows or doors, either on the frame or on the glass itself. See the instructions packaged with the glassbreak sensor for complete placement information.
Carbon monoxide (CO) alarm (TX-6310-01-1/600-6520-95)	The learn mode CO alarm alerts you to hazardous levels of carbon monoxide gas. If dangerous concentrations of gas are present, the red indicator light comes on, the internal siren goes off, and an alarm is transmitted to the panel. The panel sounds its own alarm and reports to the central station.
4-Button Key fob (600-1064-95R)	The key fob (keychain touchpad) lets you turn the system on and off from right outside the home or activate a panic alarm if there is an emergency. If you have the appropriate light control modules, you can use key fobs to turn all system controlled lights on and off.
Simon XT Talking Touchpad (60-924-3-XT)	The wall-mounted, two-way, talking touchpad combines a conventional learn mode touchpad with an RF receiver, speech chip, and voice amplification circuit.

Device	Description
Simon XT talking touch screen (60-924-RF-TS, 60-924-3-XT-2WTTS and 60-924-RF-TS-N)	The two-way talking touch screen is a wireless device that provides a graphical user interface that allows you to: arm the system (doors, windows, and motion sensors), disarm the system, activate a panic alarm to call the central monitoring station in an emergency, check system status, and turn system controlled lights on or off, all while providing voice feedback. The touch screen also provides trouble beeps, entry/exit beeps, and alarm sounds (Fire, Panic, Police).

**Caution:** Do not use outdoor motion sensors for intrusion protection.

## Standard panel

Table 2 below describes the basic panel (out-of-box) hardware capabilities for the Simon XTi 600-1054-95R-12 and 600-1054-95R-12-CN.

**Table 2: Panel hardware capabilities**

Hardware	Capability
Power	Input for an AC step-down, plug-in style transformer.
One siren output, up to two zone inputs	Terminals for connecting hardware sirens or normally closed (NC) loop switch circuits.
Phone line connection	Allows the panel to communicate with the central monitoring station and/or remote phone.

# Planning the installation

This section describes system capabilities to help you get familiar with your system. The planning sheets contain tables that let you record the hardware and programming configuration of your system. Complete all of the information ahead of time to help prepare for system installation. See “Sensor names” on page 67 for sensor name segments listed alphabetically and by index number.

Locate the panel where alarm sounds can be heard and where the panel will be easily accessible for operation. Do not install the panel near a window or door where it can be reached easily by an intruder.

## Planning sensor types and locations

The first step to an easy and successful installation is to decide what areas or items to protect, which lights to operate, and the best location for the panel, touchpad, sensors, and sirens. Metal objects, mirrors, and metallic wallpaper can block signals sent by the wireless sensors. Make sure there are no metal objects in the way when installing the system.

Use Table 3 below and Table 4 on page 5 to determine the appropriate sensor type for the sensors you will be adding, and Table 5 on page 7 to document the planned sensor information. You will need to understand the application for each sensor.

**Table 3: Recommended sensor groups**

Device	Recommended sensor group
Indoor motion sensor	15, 17 (intrusion) 18, 20, 25 (chime), 28, or 32 <sup>a</sup>
Outdoor motion sensor	25 (chime only group) <sup>b</sup>
Entry/exit door	10
Interior door	14
Window sensor	13
Smoke sensor	26 <sup>c</sup>
Glassbreak sensor	13
Key fob	01 <sup>b</sup> , 03, 06, 07
Simon XT talking touchpad	01 <sup>b</sup> , 04, 05, 06, 07
Simon XT talking touch screen	00, 01 <sup>b&amp;d</sup> , 04, 05, 06, 07
CO alarm	34 <sup>b</sup>

- a. Not certified as a primary protection circuit for UL-listed systems and is for supplementary use only.
- b. Has not been investigated by UL.
- c. Required for UL-listed residential fire alarm applications.
- d. Additional devices employing UTCFS 80 Bit Enhanced Protocol have not been investigated for use in a UL Listed installation.



**Table 4: Sensor group characteristics**

Type	Name/application	Siren type	Delay	Restoral	Supervised	Active in arming levels
00	Fixed panic: 24-hour audible fixed emergency button.	Intrusion	I	N	Y	1234
01	Portable panic: 24-hour audible portable emergency button.	Intrusion	I	N	N	1234
02	Fixed panic: 24-hour silent fixed emergency button. Status light will not blink.	Silent	I	N	N	1234
03	Portable panic: 24-hour silent portable emergency buttons. Status light will not blink.	Silent	I	N	N	1234
04	Fixed auxiliary: 24-hour auxiliary sensor.	Emergency	I	N	Y	1234
05	Fixed auxiliary: 24-hour emergency button. Siren shut off confirms CS report.	Emergency	I	N	Y	1234
06	Portable auxiliary: 24-hour portable auxiliary alert button.	Emergency	I	N	N	1234
07	Portable auxiliary: 24-hour portable auxiliary button. Siren shut off confirms CS report.	Emergency	I	N	N	1234
08	Special intrusion: Such as gun cabinets and wall safes.	Intrusion	I	Y	Y	1234
09	Special intrusion: Such as gun cabinets and wall safes.	Intrusion	S	Y	Y	1234
10	Entry/exit delay: A delay that requires a standard delay time. Chime.	Intrusion	S	Y	Y	24
13	Instant perimeter: Exterior doors and windows. Chime.	Intrusion	I	Y	Y	24
14	Instant interior: Interior door.	Intrusion	F	Y	Y	234
15	Instant interior: Interior PIR motion sensor.	Intrusion	F	N	Y	234
16	Instant interior: Interior door.	Intrusion	F	Y	Y	34
17	Instant interior: PIR motion sensor and sound sensor.	Intrusion	F	N	Y	34
18	Instant interior: Cross-zone PIR motion sensor.	Intrusion	F	N	Y	34
19	Delayed interior: Interior doors that initiate a delay before going into alarm.	Intrusion	S	Y	Y	34
20	Delayed interior: PIR motion sensor that initiates a delay before going into alarm.	Intrusion	S	N	Y	34
21	Local instant interior: 24-hour local alarm zone protecting anything that opens and closes. No report.	Intrusion	I	Y	Y	1234
22	Local delayed interior: Same as group 21, plus activation initiates a delay before going into alarm. No report.	Intrusion	S	Y	Y	1234
23	Local instant auxiliary: 24-hour local alarm zone protecting anything that opens and closes. No report.	Emergency	I	Y	Y	1234

Type	Name/application	Siren type	Delay	Restoral	Supervised	Active in arming levels
24	Local instant auxiliary: 24-hour local alarm zone protecting anything that opens and closes. Sirens shut off at restoral. No report.	Emergency	I	Y	Y	1234
25	Local special chime: Notify the user when a door is opened.	Three beeps	I	N	Y	1234
26	Fire: 24-hour fire, rate-of-rise heat, and smoke sensor.	Fire	I	Y	Y	1234
27	Lamp control or other customer feature. No report.	Silent	I	Y	Y	1234
28	PIR motion sensor, sound sensor, or pressure mat. RF thermostat. No report.	Silent	I	N	Y	1234
29	Auxiliary: Freeze sensor.	Trouble beeps	I	Y	Y	1234
32	PIR motion sensor or sound sensor. No report.	Silent	I	N	N	1234
34	Carbon monoxide alarm.	Emergency	I	Y	Y	1234
35	Entry/exit delay interior PIR motion.	Intrusion	S	N	Y	234
36	Special intrusion: Such as gun cabinets and wall safes. Reports as tamper if tripped.	Intrusion	I	Y	Y	1234
38	Auxiliary: Water sensor.	Trouble beeps	I	Y	Y	1234
39	Local instant interior: 24-hour local alarm zone protecting anything that opens and closes. No report.	Intrusion	I	Y	N	1234
40	Local special chime.	Three beeps	I	Y	Y	1234
43	Property/asset management: Notify the user that a protected asset has moved. <b>Note:</b> We recommend you use this sensor group in combination with a Simon XT Talking Touch Screen.	One beep	I	N	Y	1234

**Table 5: Sensor assignments/locations**

Sensor #	Device	Sensor group	Sensor name/location	Notes
01				
02				
03				
04				
05				
06				
07				
08				
09				
10				
11				
12				
13				
14				
15				
16				
17				
18				
19				
20				
21				
22				
23				
24				
25				
26				
27				
28				
29				
30				
31				
32				
33				

Sensor #	Device	Sensor group	Sensor name/location	Notes
34				
35				
36				
37				
38				
39				
40				

## Cross-zoning

Cross zoning (two-trip) refers to two different group 18 sensors that must be tripped within two minutes of each other to report an alarm to the central station. Figure 2 below shows the path of a person walking from the kitchen to the living room. When the person is detected walking through the kitchen, the motion sensor in the kitchen is tripped, sounding a local alarm. If motion is detected by the living room motion sensor within two minutes, an alarm report will be sent to the central station.

Figure 2: Cross-zone diagram

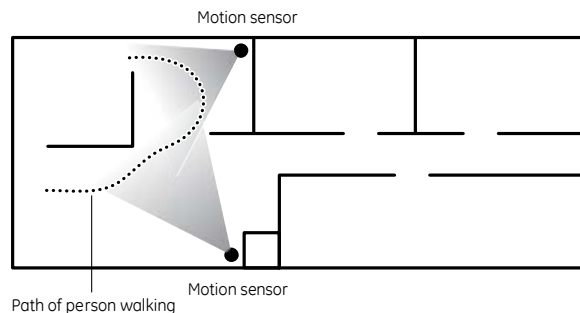

**Note:** We do not recommend cross zoning for exit/entry zones. Each zone can individually protect the intended area.

## System configuration

Table 6 below is a worksheet for you to record the desired values for each programming option. For each option, the default value, effect of deletion (pressing Disarm while editing), range, and programming privilege are listed. Each option is described in more detail in “Programming” on page 35.

In the table, the Access code column indicates what type of access code is allowed to make changes: D = dealer code, I = installer code, M = master code.

**Table 6: Programming menu options**

Function	Default	Delete	Range	Access code	Installer settings
<b>Access codes menu</b>					
Dealer code	654321, 54321, 4321, or 321	None	3 to 6 digits	D	
Installer code	654321, 54321, 4321, or 321	None	3 to 6 digits	D, I	
Master code	123456, 12345, 1234, or 123	None	3 to 6 digits	D, I, M	
User code 1	None	None	3 to 6 digits	D, I, M	
User code 2	None	None	3 to 6 digits	D, I, M	
User code 3	None	None	3 to 6 digits	D, I, M	
User code 4	None	None	3 to 6 digits	D, I, M	
User code 5	None	None	3 to 6 digits	D, I, M	
User code 6	None	None	3 to 6 digits	D, I, M	
User code 7	None	None	3 to 6 digits	D, I, M	
User code 8	None	None	3 to 6 digits	D, I, M	
Duress code	None	None	3 to 6 digits	D, I, M	
Code length	4		3 to 6 digits	D	
<b>Security menu</b>					
Account number	00000	00000	0 to FFFFFFFF	D, I	
Downloader code	12345	12345	00000 to 99999	D	
Phone lock	Off		On/Off	D	
Auto arm	On		On/Off	D, I	
Exit extension	On		On/Off	D, I	
Secure arming	Off		On/Off	D, I	
No arm on panel low battery	Off		On/Off	D, I	
Quick exit	Off		On/Off	D, I	

Function	Default	Delete	Range	Access code	Installer settings
Downloader enable	On		On/Off	D, I, M	
<b>Phone # menu</b>					
Phone #1	None	None	26 digits	D	
Phone #2	None	None	26 digits	D	
Phone #3	None	None	26 digits	D, I	
Phone #4	None	None	26 digits	D, I, M	
Downloader #	None	None	26 digits	D, I	
<b>Phone options menu</b>					
Manual phone test	On		On/Off	D, I	
Fail to communicate	On		On/Off	D, I	
DTMF dialing	On (touchtone)		On/Off	D, I	
300 bps baud rate	On (300 bps)		On/Off	D, I	
Ring/hang/ring	RHR or 10 Ring		<ul style="list-style-type: none"> <li>• RHR or 10 Rings</li> <li>• RHR(2) or 10 Rings</li> <li>• RHR(3) or 10 Rings</li> <li>• 10 Rings</li> <li>• RHR</li> <li>• RHR(2)</li> <li>• RHR(3)</li> <li>• Off</li> </ul>	D, I	
Dial delay	30 seconds	15 seconds	15 to 45 seconds	D, I	
Call waiting code	None	None	26 digits	D, I	
<b>Sensors menu</b>					
Learn sensors				D, I	
Delete sensors				D, I	
Edit sensors				D, I	
<b>Reporting menu</b>					
<b>Report options</b>					
Opening reports	Off		On/Off	D, I	
Closing reports	Off		On/Off	D, I	
Forced armed	Off		On/Off	D, I	
AC power failure report	Off	Off	5 to 254 minutes/Off	D, I	
Panel Low battery report	On		On/Off	D, I	

Function	Default	Delete	Range	Access code	Installer settings
Sensor alarm restoral report	Off		<ul style="list-style-type: none"> <li>• Sensor Close</li> <li>• Siren Timeout</li> <li>• System Disarmed</li> <li>• Off</li> </ul>	D, I	
24-hour sensor tamper report	Off		On/Off	D, I	
Supervisory/ tamper report	Off		On/Off	D, I	
No usage report	Off	Off	2 to 254 days/Off	D, I	
Swinger shutdown	On		On/Off	D, I	
Programming report	Off		On/Off	D, I	
Fire alarm verification	Off		On/Off	D, I	

#### Communication modes

Phone 1 report mode	Off		All SIA, All CID, Alarms SIA, Alarms CID, Nonalarm SIA, Nonalarm CID, Backup SIA, Backup CID, Voice dialer, or Off	D	
Phone 2 report mode	Off			D	
Phone 3 report mode	Off			D, I	
Phone 4 report mode	Off			D, I	

#### Timers menu

Entry delay	30 seconds	30	30 to 240 seconds	D, I	
Exit delay	60 seconds	45 seconds	45 to 254 seconds	D, I	
No activity timeout	Off	Off	2 to 24 hours/Off	D, I	
Auto phone test	Off	Off	1 to 254 days/Off	D, I	
Supervisory time	12:00 AM	None	12:00 AM (midnight) to 11:59 PM, None	D, I	
Alarm cancel window	6 minutes	Off	6 to 255 minutes, Off	D, I	
RF timeout	12 hours	12 hours	2 to 36 hours	D, I	
Fail to open time	Off	Off	12:00 midnight to 11:59 PM, Off	D, I	
Fail to close time	Off	Off	12:00 midnight to 11:59 PM, Off	D, I	
Siren timeout	5 minutes	Off	2 to 254 minutes, Off	D, I	
Unvacated premises	On		On/Off	D, I	
Smoke supervision	Off		On/Off	D, I	

#### Touchpad options menu

Key fob no delay	Off		On/Off	D, I	
Panic alarms	On		On/Off	D, I	

Function	Default	Delete	Range	Access code	Installer settings
Remote touchpad arming	Off		On/Off	D, I	

#### System options menu

RF jam detect	Off	Off	On/Off	D, I	
Demo mode	Off	Off	On/Off	D, I	
HW1 function	Interior siren		<ul style="list-style-type: none"> <li>• Interior Siren-Interior siren output</li> <li>• Armed-Output activated when armed</li> <li>• Disarmed-Output activated when disarmed</li> <li>• FTC-FTC output (FTC must be on)</li> <li>• Alarm-Output activated for alarm</li> <li>• Exterior Siren-Exterior siren output</li> <li>• Off-No output</li> </ul>	D	
24-hour clock	Off		On/Off	D, I	

#### Siren options menu

Panel piezo beeps	On		On/Off	D, I, M	
Panel voice	On		On/Off	D, I, M	
Panel piezo alarms	On		On/Off	D, I, M	
Trouble beeps	On		On/Off	D, I	
Voice chime	Off		<ul style="list-style-type: none"> <li>• Voice chime (sensor name)</li> <li>• Chime bell</li> <li>• Soft chime bell</li> <li>• Off-No voice chime</li> </ul>	D, I,	
Hardwired siren supervision	Off		On/Off	D, I	
Panel silent police panic	Off		On (silent), Off (audible)	D, I	
Alarm report verification	Off		On/Off	D, I	



Function	Default	Delete	Range	Access code	Installer settings
<b>Audio verification menu</b>					
Audio mode	Off		<ul style="list-style-type: none"> <li>• Instant mode</li> <li>• Callback mode</li> <li>• Off</li> </ul>	D, I	
Fire shutdown	Off		On/Off	D, I	
Fire enabled AVM	On		On/Off	D, I	
Panic talk	Off		On/Off	D, I	
Vox receiver gain	6	6	1 to 32	D, I	
Vox microphone gain	24	24	1 to 64	D, I	
Vox microphone gain range	64	64	1 to 64	D, I	
Manual microphone gain	64	64	1 to 64	D, I	
<b>System test menu</b>					
Sensor test				D, I, M	
Communication test				D, I, M	
System download				D, I, M	

# Installation

## Mounting

Figure 3: XTi chassis and trim ring

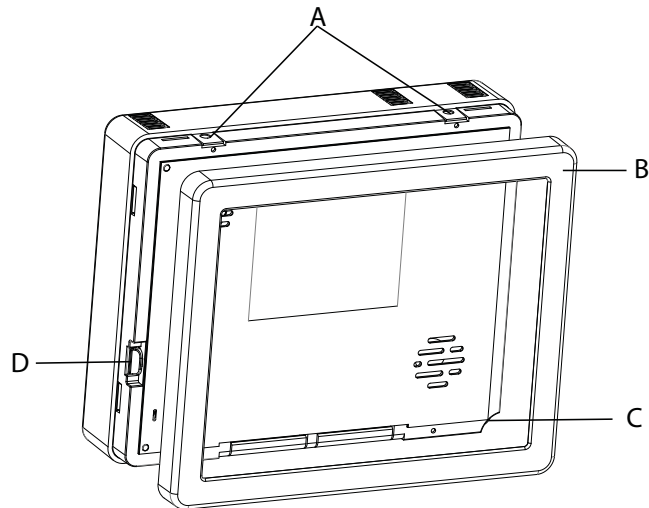

### To mount the panel on a wall:

1. Lay the panel flat on a table.
2. Remove trim ring (B in Figure 3 above) from panel by lifting at notch (C in Figure 3 above).
3. Separate the panel chassis from the mounting plate by lifting up on the tabs (A in Figure 3 above) and swinging the chassis open.
4. Choose a panel location.
5. Run all necessary power, phone, siren, and hardwired contact wires to the desired panel location.

**Note:** When choosing the AC outlet location for the AC power transformer, make sure the outlet is not controlled by a switch or that it is not part of a ground fault circuit interrupt (GFCI).

6. Hold the mounting plate against the wall and mark the mounting hole locations (Figure 4 on page 15) with a pencil.

**Note:** Mark both mounting holes in the middle of the mounting slot. This will allow better adjustment of the panel before securing it to the wall.

Figure 4: Mounting holes

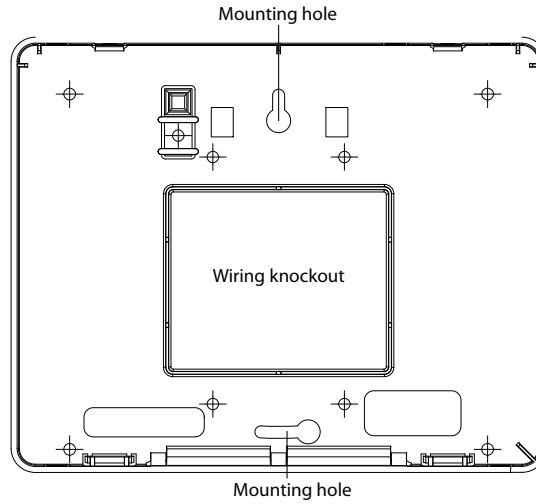

7. Secure the mounting screws (provided) to the locations on the wall marked in step 6. Do not tighten the screws. Leave enough clearance to mount the mounting plate.

**Note:** Use wall anchors if no studs are present.

8. Mount the mounting plate to the wall. Insert the top mounting hole first, then the bottom hole. Adjust the fit to make sure the mounting plate is level. Hold the mounting plate in place and tighten the screws.
9. Hang the panel chassis on the mounting plate at the plastic hinges, swing the chassis up to the mounting plate and engage at the tabs (A in Figure 3 on page 14).
10. Reattach the trim ring.

## Connecting hardwired devices

The panel has five screw terminals, two battery terminals, and two telephone connections. The screw terminals connect the AC power, sirens, and/or hardwired detectors.

Figure 5: Wiring terminals

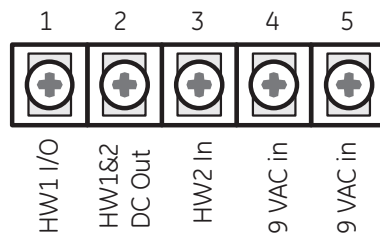

Program sensors and devices before you install them. Follow the instructions in “Sensors” on page 41 to add the sensors to panel memory.

The HW1 I/O terminal is dual purpose and can be used for either siren or hardwired contact connections. The HW2 in terminal is an input only.

### Interior sirens

From the factory, the HW1 I/O input is set up for interior siren operation (status and alarm sounds). The HW1&2 DC out terminal provides the positive (+) voltage.

**Note:** The total current available from the HW1&2 DC out terminal is 250 mA at up to 120°F (49°C). A 24-hour battery standby will be met with a maximum load of 250 mA.

With hardwired siren supervision turned on, sirens connected to HW1 I/O are supervised and require a 4.7-kohm resistor in the circuit. If this terminal is not used, turn hardwired siren supervision off.

### Hardwired interior siren

Interior sirens must always be wired with a resistor in the circuit. For circuit supervision, which allows the panel to detect if the siren wire is cut (open), the hardwired siren supervision option must be turned on.

**Note:** Do not install the resistor at the panel terminals. This does not provide supervision of the wire.

Connect the hardwired interior siren (13-374) to the panel using a 4.7 kohm resistor (included with the siren) as shown in Figure 6 below. The resistor must be connected across the siren wires as close to the siren as possible.

Figure 6: Hardwired interior siren with supervision

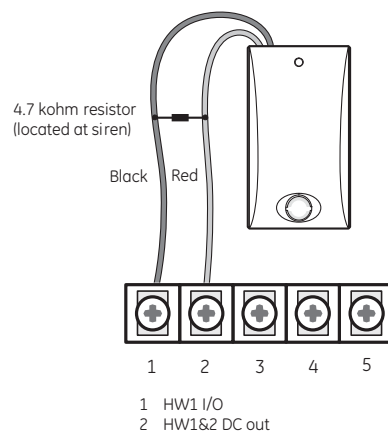

### Exterior sirens

For an exterior siren, reprogram HW1 to Exterior Siren on Option 6. See Wiring diagram.

## Hardwired contacts

To set up HW1 I/O and/or HW2 for hardwired contacts, make the required connections described below, and then proceed to “Programming” on page 35 to add (learn) them into panel memory.

You can connect hardwired reed switches (normally closed loop only) to HW1 I/O (if not being used for a hardwired siren) and/or HW2 in.

**Note:** Connect only normally closed (NC) reed switches to HW1 I/O and/or HW2 in. Other types of hardwired detectors should not be used.

The total resistance of the wired loop must not exceed 3 ohms. This allows you to use up to 200 ft. (61 m) of two-conductor, 22-gauge stranded wire.

Connect hardwired reed switches to the panel using a 47-kohm resistor (not a 4.7-kohm resistor) as shown in Figure 7 below. The resistor must be connected at the last switch in the circuit.

**Figure 7: Normally closed hardwired reed switches**

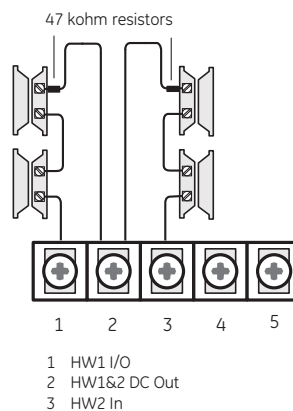

**Note:** Do not install the resistor at the panel terminals. This does not provide supervision of the wire.

## Wiring a phone line to the panel

You can connect a phone line to the panel for systems monitored by a central monitoring station or systems that notify users by a voice event notification.

DSL (digital subscriber line) allows the use of multiple devices on a single phone line simultaneously. For DSL environments, connect the panel line-in jack to an available phone jack on the premises. You may also need an inline filter to ensure panel reporting is successful.

**Note:** Avoid connecting the panel to a standard phone (voice) line as other devices on the line can prevent reports from going through.

**Figure 8: Phone connectors**

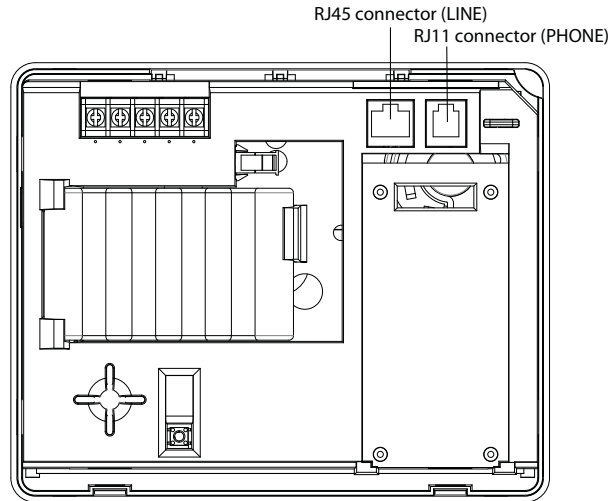

### **Full line seizure**

Full line seizure allows the panel to take over (seize) the phone line, even if another device on the line is in use. This method requires that the panel be wired before all other phones, answering machines, computers, or other devices on the phone line.

Use the RJ31X (CA-38A) jack when wiring for full line seizure. You can then quickly and easily disconnect the panel from the phone line in case the panel disables the phone line due to a malfunction.

#### **To wire full line seizure with an RJ31X:**

1. Run a four-conductor cable from the premises Telco block to the RJ31X (see Figure 9 on page 19).
2. Connect the four-conductor cable wire to the RJ31X.
3. Disconnect the green and red premises phone jack wires from the Telco block and splice them to the four-conductor cable black and white (or yellow) wires. Use weatherproof wire connectors for these splices.
4. Connect the four-conductor cable green and red wires to the Telco block TIP (+) and red to RING (-) posts.
5. Connect the phone cord included with the panel to the RJ31X and the panel LINE jack.

Figure 9: Full line seizure wiring with RJ31X

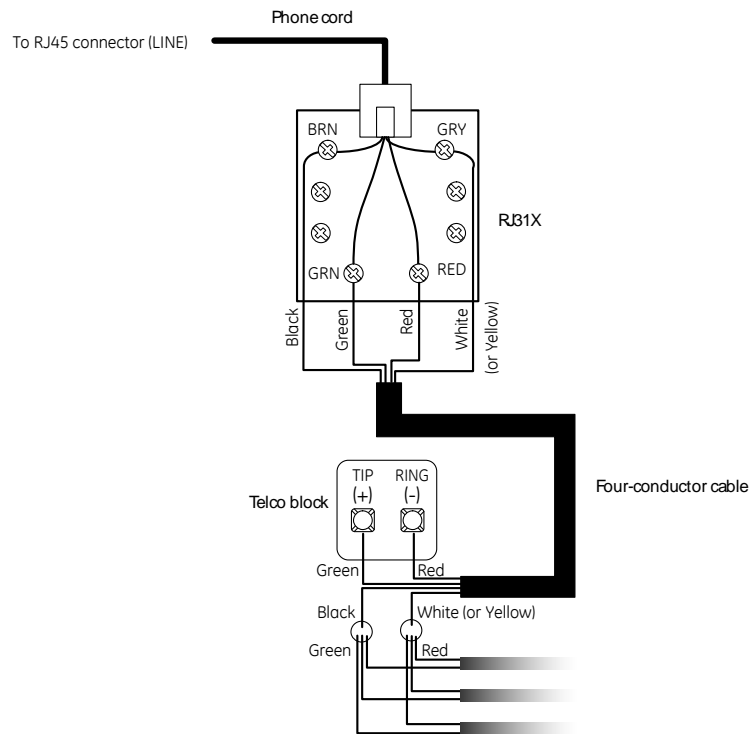

### Full line seizure wiring with one premises phone

If a single phone is all that exists on the premises, full line seizure can be accomplished without an RJ31X.

1. Disconnect the phone from the premises phone jack and plug it into the panel PHONE jack. This jack is disconnected automatically whenever the panel reports.
2. Connect the included phone cord to the panel LINE jack and the premises phone jack.

**Note:** If customers add phones or other phone devices to another phone jack, full line seizure no longer exists. Inform them to contact you if they want to add a phone or other device so that you can rewire for full line seizure by adding an RJ31X.

### Wiring the power transformer

Connect the power transformer to the two 9 VAC in terminals on the panel.

**Note:** System can only be powered up using AC power, not battery power. The red battery icon may appear when system first powers up and will disappear after some time.

Figure 10: Transformer connections

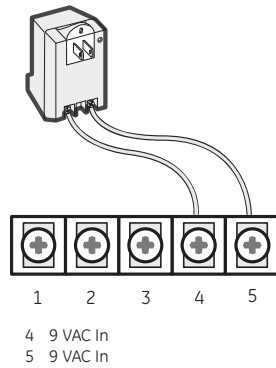

Do not plug in the transformer at this time. When applying power to the panel connect the battery first, and then plug in the AC power transformer. This sequence prevents a battery fault condition.

**Note:** Maximum battery charge current is 120 mA. It may take up to 36 hours for a new battery to fully charge.

**To remove and install the backup battery (6 VDC, 2.1 Ah):**

Figure 11: Battery installation

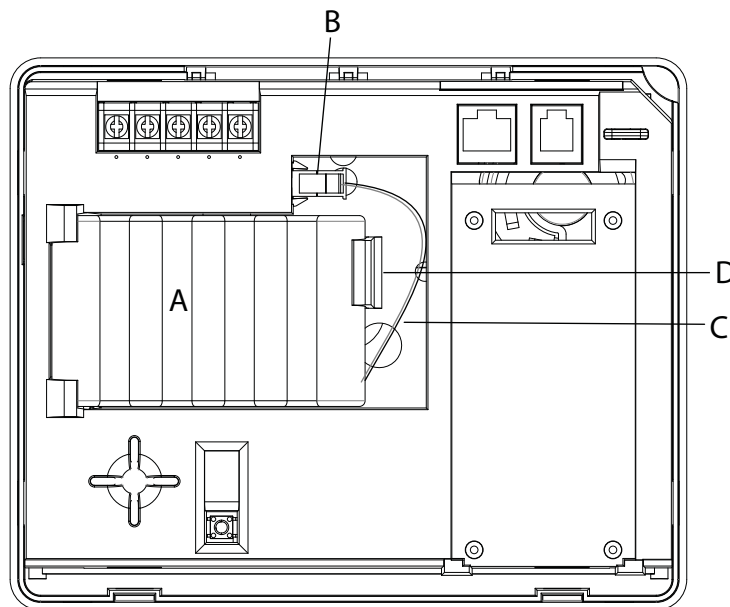

**Note:** It is recommended that the backup battery be replaced every 3-5 years.

1. Remove AC power from the panel.
2. Disconnect the existing battery (A in Figure 11 above) from the battery connector (B in Figure 11 above).



3. Remove the existing battery by reaching under the battery, next to the plastic latch (D in Figure 11 on page 20), with a finger and pulling up.

**Note:** Do not try to push the plastic latch back to remove the battery.

4. Insert the new battery into the battery compartment and snap into place.
5. Plug the battery connector into the panel.

---

**Caution:** Do not connect the battery until you are ready to power up the panel.

---

## Resetting memory to factory defaults

If you need to reset memory to factory defaults, follow the steps below.

### To reset the panel to factory defaults:

1. Remove the trim ring.
2. Open the panel cover.
3. Unplug the transformer and disconnect the battery.
4. Press and hold the reset button (D in Figure 3 on page 14) on the left side of the panel.
5. Plug in the transformer to the panel while holding the reset button and keeping the panel cover open.
6. Release the button.
7. Plug in the battery and close the panel cover.
8. Replace the trim ring.

## Applying AC power

The panel will not power up on battery power only. AC power is required to power up the panel.

Make sure the outlet is not controlled by a switch or that it is not part of a ground fault circuit interrupt (GFCI).

**Note:** For Canadian installations, plug the transformer into the wall outlet.

1. Remove the center screw from the outlet cover plate and hold the cover plate in place.

---

**WARNING:** Use extreme caution when securing the transformer to a metal outlet cover. You could receive a serious shock if a metal outlet cover drops down onto the prongs of the plug.

---

2. Plug the transformer into the lower receptacle of the outlet so that the hole in the transformer tab lines up with the outlet cover screw hole.
3. Insert the cover plate screw through the transformer tab and the outlet cover plate. Tighten the screw.

**Note:** Upon initial installation, the battery may not be fully charged for as long as 36 hours. A low battery icon will be present and trouble beeps will sound until the battery is sufficiently charged. After the initial charge, should the panel lose AC Power and experience a low battery condition, the icon will appear and trouble beeps will sound unless silenced. You can silence trouble beeps by:

- Arming or disarming the system.  
or
- Pressing the STATUS & SETTINGS icon and pressing LISTEN next to Panel Status.

This will disable the sounder for 4 hours but the trouble indication will remain until the battery is recharged.

## Designer template

The designer template is the adhesive-backed plastic template that covers the front of the Simon XT<sub>i</sub> panel.

---

**Caution:** The authorized designer template and its installation are integral parts to the reliability of the system. Replacement of the authorized designer template should be done by the security system installer.

---

### Removing the designer template

1. Remove all power (both battery and AC). Use proper ESD protection practices when replacing the designer template.
2. Remove trim ring from the panel by lifting at notch (**D** in Figure 13 on page 23).
3. Lift a corner of the template and peel back until it is removed from the front of the panel.

## Installing the designer template

Figure 12: Designer template front

---

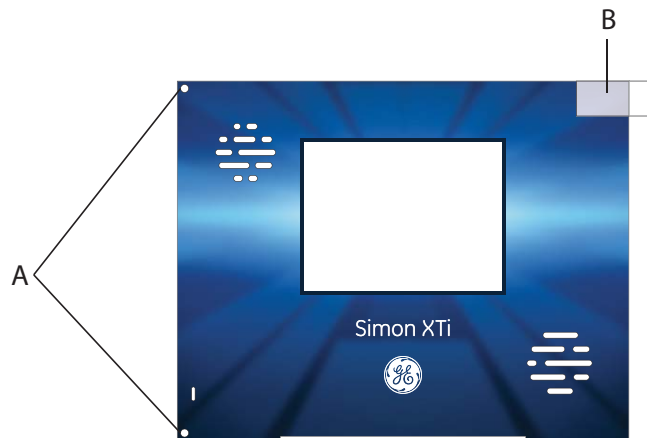
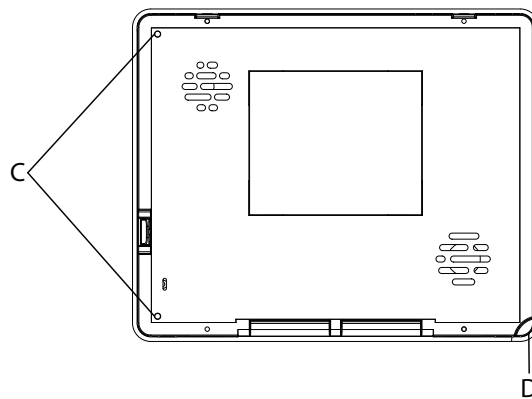

Figure 13: Panel cover

---



1. Before installing a designer template, ensure that both the display screen and cover surface are free of any lint. Wipe the surface down with a lint-free cloth.
2. Turn over the template to the back side (paper-backed adhesive side).
3. Position the template so the two alignment holes (**A** in Figure 12 above) are vertically located on your left side.
4. Starting at one of the left hand corners, partially peel back the paper backing about 2 -3 inches to the right (**F** in Figure 14 on page 24) exposing both of the two alignment holes (**E** in Figure 14 on page 24). Crease and flatten the partially removed paper backing against the back of the template.

Figure 14: Designer template back

---

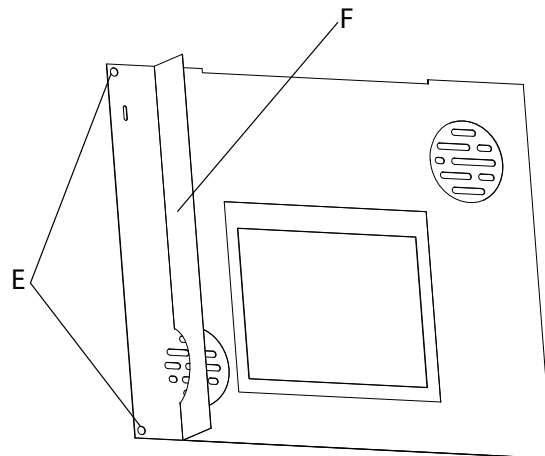

5. Turn over the template to the front (cosmetic) side.
6. Position the two alignment holes in the template (**A** in Figure 12 on page 23) over the two pins (**C** in Figure 13 on page 23) located on the cover of the panel.
7. Lightly press down on the left side of the template. Once located, reach under the template and remove the remainder of the paper backing (**F** in Figure 14 above).
8. Press down with your thumb on the template from left to right, removing any air bubbles and ensuring proper adhesion.
9. After the template is adhered to the front of the panel, remove protective film from front of template by pulling on tab (**B** in Figure 12 on page 23) in upper right hand corner.
10. Replace the plastic trim ring on panel.

# System configuration

The control panel provides the main processing unit for all system functions. The programming of system options and features is menu-driven. All installer options are set in the Programming menu, except for setting the system time and date. Figure 15 below shows the Simon XTi front panel.

Figure 15: Simon XTi front panel









**Note:** The touch screen in Figure 15 above is an example. The touch screen and system being installed may be configured differently.

Table 7 below explains the panel keys and features.

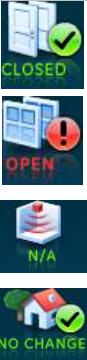
Table 7: Simon XTi panel keys and features



Item	Description
Piezo siren	Provides alarm beeps and status beeps. Fire and intrusion alarm beeps are always played at high volume, while the volume of status beeps is programmable.
Touch screen	Provides a graphical user interface for programming and system operation.
Microphone	Used to communicate with the central monitoring station after an alarm.
Speaker	Provides voice output and sounds key beeps. The panel speaks arming level change, system status, and voice chime sensor trips. The panel voice is also used for voice reporting and remote phone control.
	To access the emergency screen and select the appropriate icon (Panic, Police, or Fire), press EMERGENCY in the top left corner of the touch screen.
Time	The current system time.

Item	Description
	Depicts the status of the AC and battery. A green power cord icon represents AC power to the system. A red battery icon represents low battery power to the system. A green battery icon represents full battery power to the system.
	This will appear on the home screen in the event of an alarm. Messages will also display on this icon describing what caused the alarm. Press this icon to cancel the alarm.
	<p>These four icons depict the status of the sensors installed in your system.</p> <ul style="list-style-type: none"> <li>• A green check indicates sensors are closed or no recent activity detected.</li> <li>• A red exclamation indicates sensors are open or recent activity has been detected.</li> <li>• If the icon shows N/A, your system is not configured to support that type of sensor.</li> </ul> <p>Pressing these icons will open a new screen to provide more detail.</p>
	Press this icon to access the Arming Screen.
	<p>One of these icons will display depending on your arming level. Press to turn off intrusion/burglary protection for your system. Only intrusion/burglary sensors are disarmed. Environmental sensors, such as smoke and carbon monoxide detectors, stay active at all times Enter your code in the keypad screen that appears. If you enter an incorrect code, press the Clear icon and enter the correct code.</p> <p><b>Note:</b> In certain configurations with third party modems, the Motion Only Arming icon may not be shown.</p>
	Press to access the Status & Settings screen.

To enter the Status & Settings screen, press the  icon in the bottom right corner of the touch screen.

Press the Close icon to exit a menu or option edit mode and navigate up one level. Pressing the Close icon while in the top menu level exits the system menu level. The panel automatically exits the system menu after a few seconds of inactivity if no access code has been entered yet. After an access code has been entered to access a code-protected area of the system menu, the timeout is four minutes.

## Status & Settings menu navigation

Each menu contains a list of options and/or submenus. Press the   icons to navigate up and down the list of options and submenus in that menu. Pressing Close exits a menu and goes to the next higher level.

Programming options are arranged in a menu structure as outlined in Table 8 on page 27. The top menu contains several features, as well as the Programming menu.

When accessing the Direct Bypass, Programming, or System Tests menu, the panel prompts you to enter an access code. To continue, enter the dealer, installer or master code, and then press OK.

A gold icon indicates an option is selected.

A blue icon indicates an option is not selected.

**Table 8: Status & Settings menu structure**

Event history		
Direct bypass		
Panel status		
Chime <b>Note:</b> This option may or may not appear depending on panel programming.		
Special Chime <b>Note:</b> This option may or may not appear depending on panel programming.		
Lights <b>Note:</b> Has not been investigated by UL.		
Door lock <b>Note:</b> Has not been investigated by UL		
Voice volume		
Beep volume		
Brightness		
Default screen		
Calibration		
Help		
Set date/time		
System tests	Sensor test	
	Comm test	
	System download	
Programming	Access codes	Dealer code, Installer code, Master code, User code 1, User code 2, User code 3, User code 4, User code 5, User code 6, User code 7, User code 8, Duress code, Code length

Security	Account number, Downloader code, Phone lock, Auto arm, Exit extension, Secure arming, No arm on panel low battery, Quick exit, Downloader enable, supervisory protest
Phone numbers	Phone #1, Phone #2, Phone #3, Phone #4
Phone options	Manual phone test, Fail to communicate, DTMF dialing, 300 bps baud rate, Ring/hang/ring, Dialer delay, Call waiting code, Line cut detect (not available)
Sensors	Learn sensor, Delete sensor, Edit sensor
Reporting	Report options: Opening report, Closing report, Force armed report, AC power failure report, Panel low battery report, Sensor alarm restoral report, 24-hour sensor tamper, Supervisory/tamper report, No usage report, Swinger shutdown, Programming report, Fire alarm verification  Communication modes: Phone 1 reports, Phone 2 reports, Phone 3 reports, Phone 4 reports
Timers	Entry delay, Exit delay, No activity timeout, Auto phone test, Supervisory time, Alarm cancel window, RF timeout, Fail to open time, Fail to close time, Siren timeout, Unvacated premises, Smoke sensor supervision
Touchpad options	Keyfob no delay, Panel panic alarms, Remote touchpad arming
System options	RF jam detect, Demo mode, HW1 I/O, 24-hour clock format
Siren options	Piezo beeps, Panel voice, Panel piezo alarm, Trouble beeps, Voice chime, Status beeps vol, HW siren sup, Speaker volume, Silent police panic, Alarm report verify
Auto verification	Audio mode, Fire shutdown, Panic talk, VOX receiver gain, VOX microphone gain, VOX gain range, Manual microphone gain
System tests	Sensor test, Communication test, Initiate download call

Version

## Event history

### To view event history:

From the Status & Settings screen, press SHOW next to Event History. The Event History screen displays a history of all events recorded by the XTi system.





**Note:** If a # appears in the Event History list, the event was not sent to the central station.

## Direct bypass

### To direct bypass a sensor:

1. From the Status & Settings screen, press SELECT next to Direct Bypass.



2. Enter the master code (see Table 10 on page 36).
3. Next to the sensor name, select Bypass to bypass the selected sensor, or Not bypassed to not bypass the selected sensor.

## Panel status

### To listen to the panel status:

From the Status & Settings screen, press LISTEN next to Panel Status. The panel will announce the current status.

### To clear the panel status:

From the Status & Settings screen, press CLEAR next to Panel Status.

## Lights

### To control lights programmed into the system:

1. From the Status & Settings screen, press CONTROL next to Lights.



**Note:** If no lights are programmed into the system, the following screen will appear:

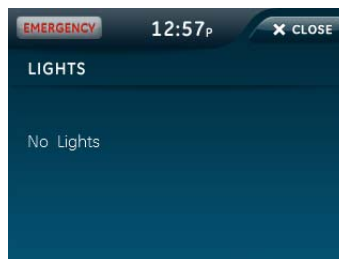

2. From the Lights screen, choose the following options:
  - Press ALL ON to turn on all system programmed lights.

- Press ALL OFF to turn off all system programmed lights.
- Press ON next to a designated light to turn that specific light on.
- Press OFF next to a designated light to turn that specific light off.



3. Press CLOSE to exit Lights screen.

## Door lock

### To control door locks programmed into the system:

1. From the Status & Settings screen, press CONTROL next to Door Lock.



**Note:** If no door locks are programmed into the system, the following screen will appear.



2. From the Door Locks screen, choose the following options:
- Press LOCK ALL to lock all system programmed door.
  - Press UNLOCK ALL to unlock all system programmed lights.
  - Press LOCK next to a designated door to lock that specific door.
  - Press UNLOCK next to a designated door to unlock that specific door.

**Note:** Open doors appear in red text.



3. Press CLOSE to exit Door Locks screen.

## Voice volume

### To adjust voice volume:

From the Status & Settings screen, next to Voice Volume, press the left arrow to lower the voice volume and the right arrow to raise the voice volume. The bars between the arrows register the volume level. No bars is off. Four bars is loudest.



## Beep volume

### To adjust beep volume:

From the Status & Settings screen, next to Beep Volume, press the left arrow to lower the beep volume and the right arrow to raise the beep volume. The bars between the arrows register the volume level. One bar is softest. Four bars is loudest.



## Brightness

### To adjust brightness:

From the Status & Settings screen, next to Brightness, press the left arrow to make the screen less bright and the right arrow to make the screen more bright. The bars between the arrows register the brightness level. One bar is least bright. Four bars is brightest.



## Default screen

### To change the default screen:

From the Status & Settings screen, press MAIN or BLANK next to Default Screen. To make options visible on a blank screen, touch anywhere on the screen. The screen will stay visible for two minutes before returning to blank mode, if untouched.



## Calibration

Normally you will not need to calibrate the touch screen, but if the touch screen icons do not respond correctly, follow the instructions below.

### To calibrate the screen:

1. From the Status & Settings screen, press SHOW next to Calibration.



2. Touch the center of the cross using a soft, fine point as it appears in each corner of the screen.



After the cross in the fourth corner (bottom right) is pressed, the user will be returned to the Status & Settings screen.

If you cannot access the calibration using the above procedure, use the following steps:

1. Remove the trim ring from the front of the panel.
2. Press and hold the Reset button (**D** in Figure 3 on page 14).
3. Press and hold anywhere on the screen.
4. While you are pressing the screen, release the Reset button.
5. Follow the calibration prompts.

## Help



### To access the Help screens:

1. From the Status & Setting screen, press the HELP icon.



2. From the SYSTEM HELP screen, choose the help topic to search.



3. Press  and  to scroll through help topics.
4. Press CLOSE to return to the previous screen.

### Set time and date

If the panel loses both AC and battery power, upon power restoral the system time will reset to midnight and the date will reset to 1 - 1 - 2000, indicating it has not been set correctly.

Time format is: hour/minute/a.m. or p.m.

Date format is: month/day/year:

### To set the time

1. From the Status & Settings screen, select Set Date/Time.
2. Enter access code.
3. From the Set Date/Time screen press the first box to set the hour and press SAVE.
4. Press the second box to set the minutes and press SAVE.
5. Press a.m/p.m. box to toggle a.m/p.m. setting.



### **To set the date**

1. From the Set Date/Time screen press the first box in the second row to set the month and press SAVE.
2. Press the second box to set the day and press SAVE.
3. Press the third box and enter the year and press SAVE.
4. Press CLOSE repeatedly to exit.

### **Version**

To display the system's firmware version, touch screen version, and copyright information, scroll until the display shows Version on the bottom of the screen.

# Programming

## To enter programming:

1. From the Status & Settings screen, press  to scroll to the Programming option.
2. Press Enter.
3. Enter the dealer or installer code (see Table 9 below) and press OK.

**Note:** You have four seconds between number presses to enter the code or you will be returned to the home screen.

**Note:** Do not remove the panel power within 30 seconds of exiting program mode.

Table 9: Simon XTi programming codes

Code	Description
Dealer code	You can use the dealer code to program all system functions, including high-security options that are not accessible with the installer code if it is different from the dealer code. Depending on how the access code is set, the default dealer access code is 654321, 54321, 4321 (factory default), or 321. This code can be used for all programming.
Installer code	Depending on how the access code is set, the default installer code is 654321, 54321, 4321 (factory default), or 321. This code is limited to changing all but the following: Dealer code, code length, downloader code, phone lock, phone #1, phone #2, phone 1 report mode, phone 2 report mode, HW1 function.

The following sections describe the programming options in the Programming submenus.



## Access codes

### To add/edit access codes:

1. From the Programming screen, press ACCESS CODES.
2. To add or edit an access code, press the white field next to the access code.



3. Enter the new/edited code on the numbered keypad and press SAVE.
4. Press CLOSE repeatedly to exit menus

**Table 10: Access Codes menu**

Function	Default	Description
Dealer code	4321	You can use the dealer code to program all system options, including high-security options that are not accessible with the installer code if it is different from the dealer code. Changing the dealer code to differ from the installer code will prevent the installer from viewing certain fields.  If you change the dealer code and enter program mode with the installer code, the installer will no longer be able to see the following: code length, downloader code, phone lock, phone #1, phone #2, phone 1 report mode, phone 2 report mode, HW1 function.
Installer code	4321	You can use the installer code to program most installer options, except for high-security dealer options.
Master code	1234	You can use the master to arm/disarm, enter user programming, and bypass sensors.
User codes 1 to 8	Blank	You can use the user codes to arm/disarm the system.
Duress code	Blank	Use the duress code in place of the master or user code to cause a silent alarm.
Code length	Four digits	Codes can be three to six digits long.

## Security

### To add/edit account number or downloader code:

1. From the Programming screen, press SECURITY.
2. To add or edit an account number or downloader code, press the white field next to account number or downloader code.





3. Enter the new/edited code on the numbered keypad and press SAVE.

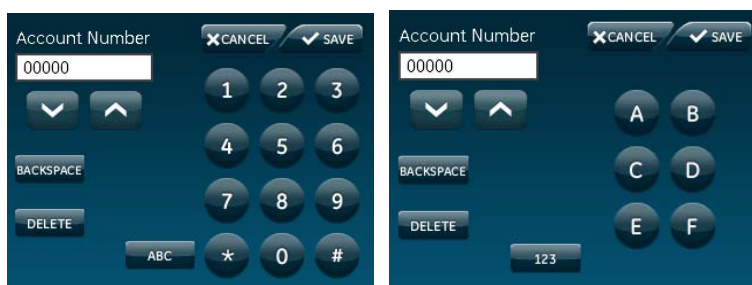

**Note:** The account number can be alphanumeric. To enter letters, press the ABC icon. To enter numbers press the 123 icon.

**To edit phone lock, auto arm, exit extension, secure arming, no arm on low battery, quick exit, and downloader enable options:**

1. From the Programming screen, press SECURITY.
2. To turn on an option, press . To turn off an option, press .

**Note:**  indicates the option is turned on.

3. Press CLOSE repeatedly to exit menus.

**Table 11: Security menu**

Function	Default	Description
Account number	00000	Lets you program up to a 10-character alphanumeric account number or delete an existing account number by pressing Disarm. You can enter numerical digits sequentially. Account numbers with letters A through F, or numbers 0 through 9 (or a combination of those letters and numbers) are only supported.
Downloader code	12345	Lets you set a unique five-digit code that is required for initiating Enterprise Downloader sessions. The code must be five digits long and can range from 00000 to 99999. The downloader code must match the downloader access code in the Enterprise account to perform Enterprise sessions.

Function	Default	Description
Phone lock	Off	Prevents resetting of phone/reporting related options when a memory clear is performed (on) or resets these options to their default values when a memory clear is performed (off). The following are not reset when on: account number, dealer code, code length, call wait cancel, phone numbers 1 and 2, phone report modes 1 to 4, phone lock, downloader phone number and downloader code.
Auto arm	On	<p>Determines how long the system protests (announces open/failed sensors) when attempting to arm with open/failed sensors, before bypassing these sensors and automatically arming the rest of the system. The panel protests an arming attempt when it has not received a restore (close) signal from sensors learned into restore-specific sensor groups. Sensors learned into group 26 (fire) cannot be bypassed.</p> <p>When this option is on, the panel announces all open/failed sensors repeatedly for four minutes, then automatically bypasses the open sensors and arms the rest of the system. If a sensor is opened during the exit delay and then left open, the panel will go into alarm after the exit delay has expired. This option must be on for unvacated premises and exit extension to work correctly.</p> <p>When the option is off, the panel displays all open/failed sensors once, then automatically bypasses the open sensors and arms the rest of the system after the exit delay has expired. If other sensors are opened during the exit delay, they will also be bypassed if left open.</p> <p>If group 13 (instant perimeter) sensors are opened during the exit delay, the panel goes into immediate alarm.</p>
Exit extend	On	<p>Determines whether the panel restarts the exit delay time if you enter the armed premises during the initial exit delay period (on), or not (off). Turning on this feature allows you to reenter during the exit delay period, without disarming and then rearming the system. Turning off this feature requires you to disarm and rearm the system.</p> <p><b>Note:</b> Auto arm must be on for this option to work.</p>
Secure arming	Off	Determines whether an access code is required when arming the system (on), or not (off). This option does not affect key fob arm/disarm operation.
No arm on low battery	Off	Determines whether the system protests arming if a low CPU battery condition exists (on), or not (off).
Quick exit	Off	Determines whether pressing Disarm when the system is armed activates the exit delay time to allow exit and reentry without disarming the system (on), or not (off). This feature is useful if you want to step outside briefly and return. If the system is armed and you press Disarm, the panel announces Exit Time is On, and sounds exit delay beeps. This allows a designated entry/exit door to open for up to two minutes without causing alarm. When the door is closed, the beeps stop and the door is armed again.
Downloader enable	On	Enables programming of system options with downloader software.

## Phone numbers

To add/edit phone numbers:

1. From the Programming screen, press PHONE NUMBERS.
2. To add or edit a phone number, press the white field next to the phone number.

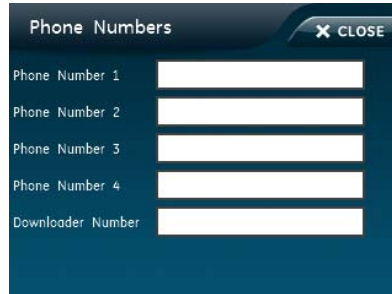

3. Enter the new/edited phone number on the numbered keypad and press SAVE.
4. Press CLOSE repeatedly to exit menus.

Table 12: Phone Numbers menu

Function	Default	Description
Phone #1	Blank	Lets you program up to a 26-digit central monitoring station receiver/voice event notification phone number for monitored systems. Phone digits can be 0 to 9, *, #, or a pause (P).
Phone #2	Blank	
Phone #3	Blank	To delete the phone number, press Delete on the keypad while editing a phone digit. To add a pause to the phone number, press Pause on the keypad.
Phone #4	Blank	
Downloader #	Blank	Lets you program up to a 26-digit phone number for the Enterprise Downloader.

## Phone options

To edit manual phone test, fail to communicate, DTMF dialing, and 300 BPS enabled options:

1. From the Programming screen, press PHONE OPTIONS.

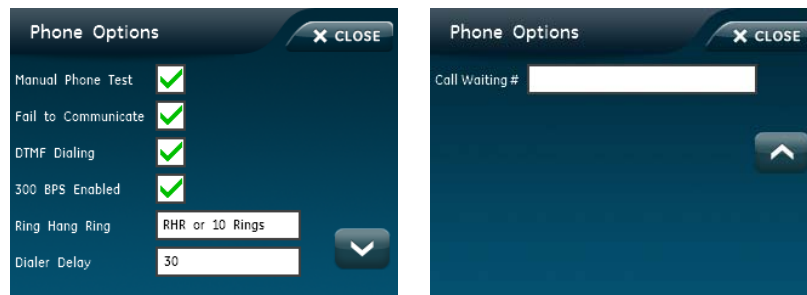

- To turn on an option, press . To turn off an option, press .

**Note:**  indicates the option is turned on.

- Press CLOSE repeatedly to exit menus.

#### To edit ring hang ring option:

- From the Phone Options screen, press the white field next to Ring Hang Ring.
- To turn on an option, press . To turn off an option, press .

**Note:**  indicates the option is turned on.

- Press CLOSE repeatedly to exit menus.

#### To edit dialer delay option:

- From the Phone Options screen, press the white field next to Dialer Delay.
- Enter the new/edited dialer delay time on the numbered keypad and press SAVE.
- Press CLOSE repeatedly to exit menus.

#### To edit the call waiting # option:

- From the Phone Options screen, press the white field next to Call Waiting #.
- Enter the new/edited call waiting # on the numbered keypad and press SAVE.
- Press CLOSE repeatedly to exit menus.

**Table 13: Phone Options menu**

Function	Default	Description
Man phone test	On	Determines whether you can perform a manual communication test to verify communication to a central station/voice dial (on), or not (off). If you have all four phone numbers programmed, it should send a test report to all four before showing that the test is okay.
FTC	On	Determines whether the panel and interior sirens sound trouble beeps if it is unable to successfully send a report to a central station (on), or not (off).
DTMF dial	On	Determines whether the panel uses DTMF (on) or pulse (off) for dialing programmed phone numbers.
300 bps enabled	On	Determines whether the baud rate used by the panel for central station communication is 300 bps (on), or 110 bps (off).

Function	Default	Description
Ring hang ring	RHR or 10 Rings	<p>Determines when the panel answers a remote phone access or Enterprise call. Depending on whether an answering machine exists at the panel location, offsite access to the panel can be done with a series of phone calls or just one. For offsite access where an answering machine does not exist, the user or Enterprise operator simply calls the panel location once and listens for 10 rings. The panel should answer after the tenth ring.</p> <p>For offsite access where an answering machine exists, the user or Enterprise operator must call the panel location, and then let the phone ring once and hang up. Wait at least 10 seconds but not more than 40, and then call the panel location again. The panel should answer on the first ring.</p> <p>Ring/hang/ring setting number and sequence of rings after which the panel answers:</p> <ul style="list-style-type: none"> <li>• RHR or 10 Rings = Ring/hang/ring or ten rings</li> <li>• RHR(2) or 10 Rings = Ring/hang/ring/hang/ring or ten rings</li> <li>• RHR(3) or 10 Rings = Ring/hang/ring/hang/ring/hang/ring or ten rings</li> <li>• 10 Rings = Ten rings</li> <li>• RHR = Ring/hang/ring</li> <li>• RHR(2) = Ring/hang/ring/hang/ring</li> <li>• RHR(3) = Ring/hang/ring/hang/ring/hang/ring</li> <li>• Off = Disabled, no remote (offsite) access</li> </ul>
Dial delay	30 seconds	<p>Determines whether the panel delays dialing programmed phone numbers before sending report (on).</p> <p>If opening (disarming) reports is on, the panel does not delay dialing if the system is disarmed before the delay time expires. The panel dials immediately for both the alarm and opening report.</p> <p>Regardless of this option setting, the panel always dials immediately for fire alarms, AC power failure, and low battery reports.</p>
Call waiting #	Off	<p>The call waiting number is dialed by the panel before a phone number to disable call waiting. If the end-user has call waiting, we recommend you change this option from its default.</p> <p><b>CAUTION:</b> Changing this option from its default without call waiting will prohibit the panel from calling the central station.</p> <p>The call waiting code is programmed the same way as a dialer number.</p>

## Sensors

Table 14: Sensors menu

Function	Description
Learn sensors	Adds (learns) sensors to panel memory.
Delete sensors	Deletes sensors from panel memory.
Edit sensors	Edits sensor information in panel memory.

The following instructions tell how to add (learn) sensors, touchpads, and other system devices into panel memory. The panel recognizes a sensor when you press a sensor program button, press and release a tamper switch, press a sensor test button, or put a sensor into alarm. Table 15 on page 44 below describes the programming method for each device.

**To learn (program) and edit a sensor:**

1. From the Programming screen, press SENSORS.
2. From the Sensors screen, press LEARN SENSORS.



3. Press the sensor program button or release the sensor tamper switch. The Edit Sensor screen will appear.



4. To change the sensor number, press EDIT next to Sensor Number, enter the new sensor number, and press SAVE.

**Note:** The sensor number can only be edited during sensor learning.

5. To change the sensor group, press EDIT next to Sensor Group, enter the new sensor group, and press SAVE.
6. To change the sensor name, press EDIT next to Sensor Name, press EDIT next to the item number to be changed, scroll through and press the correct name from the list, and press SAVE.

**Note:** Default the screen to List and not Keypad. This gives the user the list of stored sensor names.

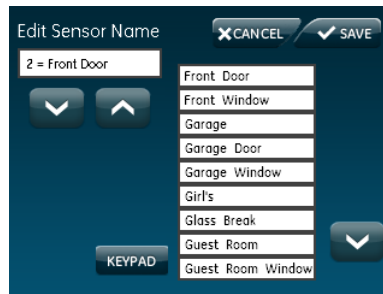

7. Press SAVE to save the changes.
8. Press CLOSE to return to the Sensors screen.

**To delete a sensor:**

1. From the Programming screen, press SENSORS.
2. From the Sensors screen, press DELETE SENSORS.



3. Press DELETE next to the sensor to be deleted.
4. Press CLOSE to return to the Sensors screen.

**Mounting Recommendations:**

- Where possible, install sensors within 100 feet (30 m) of the receiver. While a transmitter and receiver combination may have an open-air range of 500 feet (152 m) or more, the environment at the installation site may have a significant effect on operational range. Changing a sensor or receiver location can improve wireless communication.
- Avoid mounting sensors or receivers in areas where they will be exposed to moisture or where the operating temperature range will exceed the specified range (10 to 120 °F).
- Avoid mounting the sensor or receiver in areas with a large quantity of metal or electrical wiring. For example: within 1 meter of AC distribution panel (fuse box), HVAC duct work.
- Avoid mounting the sensor or receiver directly on metal.
- The Simon XT<sub>i</sub> system should not be mounted within 3 meters of any other RF equipment (RF music system transmitter, wireless router/modem, etc.).

**Note:** Refer to specific sensor installation instructions for complete operation and testing details.

**Table 15: Device programming**

Device	To program
Door/window sensor	Press the button on the top of the sensor (cover removed) or trip the tamper.
Motion sensor	Press the button on the back of the sensor (mounting plate removed) or trip the tamper.
Smoke detector	Trip the tamper, press the test button, remove the detector from its base, or put the smoke detector into alarm.
Hardwired sensor	Separate the sensor from its magnet.
Glassbreak sensor	Trip the tamper switch on the sensor.
CO alarm	Trip the wall tamper by removing the sensor body from the mounting plate.
Simon XT talking touch screen	<ol style="list-style-type: none"> <li>1. Press the Settings icon.</li> <li>2. Press the Down arrow until the Clear and Enroll icon appears.</li> <li>3. Press the Clear and Enroll icon. The touch screen should indicate it is waiting for enrollment.</li> </ol>
Simon XT talking touchpad	Press the Lights off button on the touchpad six times in rapid succession. On the sixth press, the touchpad makes a longer beep.
Key fob	Press the Lock and Unlock buttons at the same time.

**Note:** If you are installing a sensor on a gun case, jewelry box, or a similar case, and the sensor is active in level one, you must bypass the sensor to avoid putting the panel into alarm when the sensor and the magnet are separated.

### Sensor association with the graphical interface icons

**Figure 16: At a glance icons**

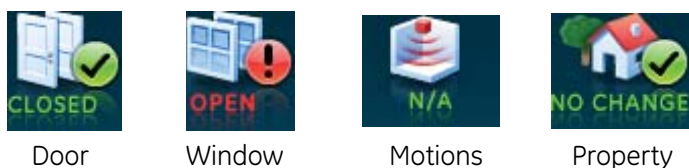

The at-a-glance icons (see Figure 16 above) Door, Window, Motions, and Property, found on the Simon XT<sub>i</sub> (and remotely connected Talking Two-Way Touch Screens) are associated with sensors, given a set of rules.

- The default state for an disassociated at-a-glance icon is N/A.
- Any learned-in sensor (regardless of type or group) with a sensor name that includes the word “window” or “door” from the text library will automatically associate respectively with the at-a-glance Doors and Window icons. Example, a



door-window sensor learned in, and physically attached to a door, with Front Door as its name, group 10 as its type will be associated with the Doors icon on the graphical interface. In contrast, a door-window sensor learned in, and physically attached to a door, with Utility Room as its name, group 10 as its type will NOT be associated with the Doors icon. It would be associated with the property icon on the graphical interface.

- Any learned-in sensor (regardless of type or name) with a group type of 17, 18, 20, or 28, will associate with the at-a-glance Motions icon. Depending on the location of the screen, a typical use for this feature would be to identify motion before entering the building (if placed in a garage), or alerting to motion downstairs from the master bedroom, if the system wasn't armed. The Motion icon will clear after 10 minutes of inactivity.
- Any sensor that is not associated with the Doors, Window, or Motions icons based on the preceding rules is automatically associated to a Property icon.
- The Property Icon supports two different sensor group types restoral, and non-restoral. Restoral based sensors, provide clear indication of event start and stop. An example is a flood sensor. The flood sensor will associate with the Property icon and continue to report as "Changed" when water is detected and remains detected by the sensor. When the water condition clears, the Property icon Open will clear. Non-restoral based sensors, provide indication of event start, but not stop. An example is tilt switch/garage door sensor that determines if something that it is attached to the sensor, like a boat trailer has moved. The tilt sensor will associate with the Property icon and will report as "Changed" when movement is detected the first time. Upon user acknowledgement of the event by pressing the Property icon, the Changed state is returned to No Change.

### **Common associations of icons and sensors**

- Exteriors motions for use in driveways for non-reporting, informational purposes can be associated with the Property icon using group types 40 or 43.
- Water sensors learned group 29 will alarm immediately upon activation; if informational detection is desired without reporting, use group 40.
- Freeze sensors learned group 38 will alarm immediately upon activation; if informational detection is desired without reporting, use group 40.
- Tilt sensors can be used as a means to provide asset monitoring associated with the Property icons with the use of group type 43.

## **Reporting**

### **To turn on/off reporting options:**

1. From the Programming screen, press REPORTING.



2. From the Reporting screen, select REPORTING OPTIONS.

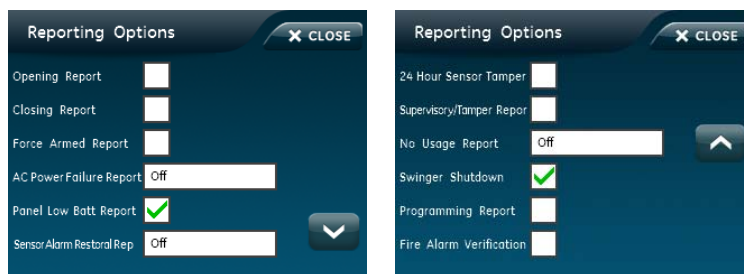

3. To turn on an option, press . To turn off an option, press .

**Note:**  indicates the option is turned on.

4. Press CLOSE to return to the Reporting screen.

**Table 16: Reporting menu**

Option	Default	Description
Opening reports	Off	Determines whether the panel sends opening reports to a central station whenever the system is disarmed (on), or not (off). The User number will be reported as zone number. Key fobs learned into zones 1 to 40 will report as that zone.  Dealer code = 44, Installer code = 45, Master code = 46, User code 1 = 47, User code 2 = 48, User code 3 = 49, User code 4 = 50, User code 5 = 51, User code 6 = 52, User code 7 = 53, User code 8 = 54, Duress code = 55
Closing reports	Off	Determines whether the panel sends closing reports to a central station whenever the system is armed (on), or not (off). The User number will be reported as the zone number. Key fobs learned into zones 1 to 40 will report as that zone.  Dealer code = 44, Installer code = 45, Master code = 46, User code 1 = 47, User code 2 = 48, User code 3 = 49, User code 4 = 50, User code 5 = 51, User code 6 = 52, User code 7 = 53, User code 8 = 54, Duress code = 55
Force armed	Off	Determines whether the panel sends by force armed report to a central station if the user bypasses protesting sensors (indirect bypass) when arming the system (on), or not (off).

Option	Default	Description
AC Power failure Report	Off	Determines whether the panel sends AC power failure reports to a central station after the programmed time expires. The time can be set from 005 to 254 minutes. When the panel is without AC power for 30 seconds, the panel screen turns off. When the panel is without AC power for the programmed time, an AC power failure is reported. The panel reports an AC power restoral when AC power returns to the panel.
Panel Low Battery Report	On	Determines whether the panel sends a low CPU battery report to the central station when the panel backup battery voltage drops.
Sen alarm restore	Off	Determines whether the panel reports sensor alarm restoral (on), or not (off). Setting when restoral is reported: <ul style="list-style-type: none"> <li>• Sensor Close - Immediately after sensor is closed or restored after dial delay</li> <li>• Siren Timeout - After siren timeout expires if sensor is restored</li> <li>• System Disarm - When system is disarmed if sensor is restored.</li> <li>• Off</li> </ul>
24-hour sensor tamper	Off	Determines whether the system (armed or disarmed) goes into and reports an alarm anytime a sensor tamper switch is tripped (on), or only when the system is armed and a tamper switch of an armed sensor is tripped (off).
Supervisory/tamper	Off	Determines whether the panel sends supervisory reports to a central station as a tamper (on), or a supervisory (off). <b>Note:</b> This option is typically used only in Europe where a supervisory condition is required to report as a tamper.
No usage	Off	Determines whether the panel sends a No Usage report to the central station if the user has not operated the system before the programmed time expires (on), or not (off). The timer starts each time the system is disarmed. <b>Note:</b> This is a customer service feature that alerts the central station if a customer is not using their security system. The service provider can then contact the customer to find out why the system is not being used, and help correct any problems for the customer.
Swinger shutdown	On	This setting determines if a sensor or zone will go into alarm only once during an arming period (an active arming level) and will not be active again until the alarm is canceled (swinger Shutdown is enabled) or the sensor or zone will always be active and will go into alarm multiple times during an arming period (an active arming level) without canceling the alarm (Swinger Shutdown is disabled).  On = 1 trip Off = unlimited trips  <b>Note:</b> Swinger shutdown does not affect Smoke, Fire, Carbon Monoxide, and Environmental sensors learned into groups 26 (Fire/Smoke), 29 (Freeze), 34 (CO), and 38 (Water).

Option	Default	Description
Programming report	Off	Determines whether the panel sends a report to the central station anytime the programming mode is entered/exited (on), or not at all (off). The panel sends a report whenever the dealer (Utility 1) or installer (Utility 2) code is used to enter programming mode and another report is sent when the programming session ends.
Fire Alarm Verification	Off	If this option is off, the panel immediately reports to the central station when a smoke detector goes into alarm. With this option on, if a single smoke detector goes into alarm, the panel will not report for 60 seconds unless another smoke detector goes into alarm. If the first smoke detector is cleared of alarm within the first 60 seconds, no report will be sent to the central station unless it or a second smoke detector goes into alarm within the panel siren timeout period (5 minutes).

### To edit communication modes options:

1. From the Programming screen, press REPORTING.
2. From the Reporting screen, select COMM MODES.



3. From the Communication Modes screen, press the white field next to the correct Phone Report Mode to edit.

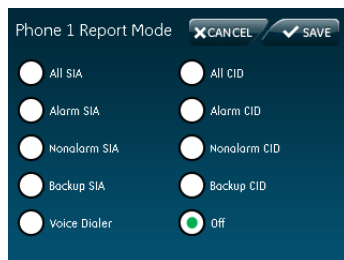

4. Select, by pressing  next to the correct option.

**Note:**  indicates the option is turned on.

**Table 17: Communication modes**

Option	Default	Description
Phone 1 report mode	Off	Determines how the panel sends a report to the central station for each of the phone numbers programmed.
Phone 2 report mode	Off	

Option	Default	Description
Phone 3 report mode	Off	The options are: All SIA, All CID, Alarm SIA, Alarm CID, Nonalarm SIA, Nonalarm CID, backup SIA (phone failure backup), Backup CID (phone failure backup), Voice dialer, Off
Phone 4 report mode	Off	

Alarms include: Fire, Intrusion, Emergency, Silent, and Alarm Cancels.

Nonalarms include: No Activity, Openings, Closings, Fail-to-Open, Fail-to-Close, Force Armed, AC Power Failure, CPU Low Battery, and Trouble Restoral.

## Timers

### To edit timer options:

1. From the Programming screen, press TIMERS.

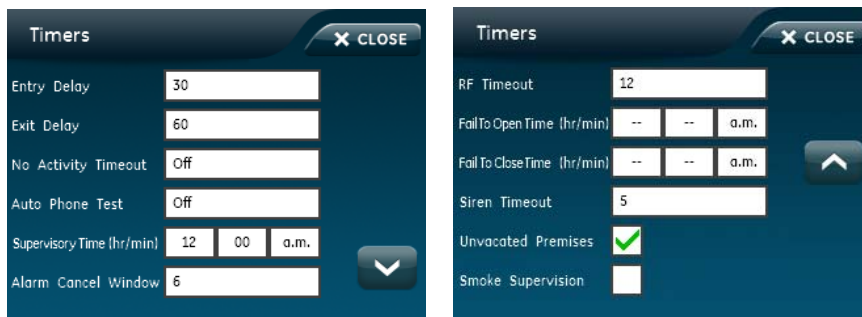

2. From the Timers screen, press the white field next to the Timer option to edit.
3. Enter the value on the numbered keypad.

OR

To turn an option on, press . To turn an option off, press .

**Note:**  indicates the option is turned on.

4. Press SAVE to save the changes.
5. Press CLOSE to return to the Programming screen.

**Table 18: Timers menu**

Function	Default	Description
Entry delay	030 seconds	Determines how much time you have to disarm the system after entering the armed premises through a designated delay door, before an alarm occurs. Beeps sound during the entire delay time to remind you to disarm the system. When turned on, the entry delay can be set from 030 to 240 seconds.

Function	Default	Description
Exit delay	060 seconds	Determines how much time you have to leave the premises through a designated delay door after arming the system. Beeps sound after arming the system to remind you to leave the armed premises. If a delay door is opened after the exit delay expires, the entry delay begins. If you arm the system with no delay and open a delay door after the exit delay expires, an alarm occurs.
No activity tm	Off	Determines whether the panel sends a no activity report to a central station when the programmed time elapses (on), or if the feature is disabled (off). No activity means the control panel, remote handheld, and key-chain touchpad buttons have not been pressed and sensors have not been tripped within a specified time (except sensors in group 25 and 43). The timeout can be set from 02 to 24 hours.
Auto phone test	Off	Determines whether the panel automatically performs a periodic phone test (on), or not (off). The test interval can be from 001 to 254 days. The time of day the panel performs the test is determined by the supervisory time, which must be turned on for this feature to work.
Supervisory time	12:00am	Determines when the panel reports supervisory conditions (sensor failures) and automatic phone tests to the central station. The panel clock must be set to the correct time for this option and the automatic phone test to work correctly.
Alarm cancel	006 minutes	Sets the time frame that determines whether the panel reports an alarm cancel message to the central station. If the system is disarmed from an alarm state within the programmed time, the panel sends an alarm cancel message to the central station. An alarm cancel message is not reported if the system is disarmed after the programmed time expires.  The time can be set from 006 to 255 minutes. When set to 255, the panel always reports alarm cancel messages. Turning off this option disables alarm cancel reporting.
RF time-out	12 hours	Determines the period during which the panel must receive at least one supervisory signal from learned sensors before identifying a sensor failure and sounding trouble beeps. Any sensor failure is reported immediately and again at the supervisory time. The timeout can be set from 02 to 36 hours. Entries must be two digits.
Fail-to-open time	Off	Determines whether the panel sends a fail-to-open report to a central station if the system has not been disarmed by the programmed time (on), or not (off). System time must be set correctly for this feature to work.
Fail-to-close time	Off	Determines whether the panel sends a fail-to-close report to a central station if the system has not been armed by the programmed time (on), or not (off). System time must be set correctly for this feature to work.

Function	Default	Description
Siren time-out	005 minutes	Determines how long sirens sound alarms if no one is present to disarm the system. The time can be set from 002 to 254 minutes. When this feature is turned off, sirens sound alarms until the alarm is canceled (system disarmed).
Unvacated premises	On	Unvacated premises is a feature that determines whether the system automatically arms down to level 2 (doors and windows) if you arm the system to level 4 (doors, windows, and motion sensors) without opening or closing a perimeter door (on), or remains at the armed level chosen (off). This feature does not work from a key fob. Autoarm must be on for this feature to work.
Smoke supervision	Off	Determines how often the panel must receive supervisory signals from the smoke sensors. If this option is on, the panel must receive at least one supervisory signal from smoke sensors every four hours or it will identify a sensor failure and sound trouble beeps. If this option is off, the time for receiving supervisory signals is determined by RF timeout.

## Touchpad options

### To edit touchpad options:

1. From the Programming screen, press TOUCHPAD OPTIONS.



2. To turn an option on, press . To turn an option off, press .

**Note:**  indicates the option is turned on.

3. Press CLOSE to return to the Programming screen.

**Table 19: Touchpad Options menu**

Function	Default	Description
Keyfob no delay	Off	Determines whether a key fob arms the system with no delay (on), or not (off). When this feature is on, you must disarm the system before entering the premises, since it is disabling the entry delay. If the remote touchpad arming option is on, key fobs cannot disarm the system and will cause an alarm upon entering.
Panic alarms	On	Determines whether the panel panic icons (police, panic, and fire) activate alarms when pressed (on), or not (off).

Function	Default	Description
Remote TP arm	Off	Determines whether key fobs and remote touchpads can disarm the system only during exit and entry delays (on), or arm and disarm the system anytime (off). If this option and the key fob no delay option are on, you cannot enter and/or disarm using remote touchpads without causing an alarm.

## System options

### To edit system options:

1. From the Programming screen, press SYSTEM OPTIONS.

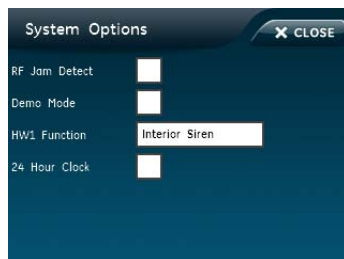

2. For RF jam detect, demo mode, and 24 hour clock; to turn an option on, press .

To turn an option off, press . Go to Step 5.

OR

Press the white field next to the HW1 function option to edit.

3. Select an option on the HW1 function screen by pressing  next to the correct option.

**Note:**  indicates the option is turned on.



4. Press SAVE.
5. Press CLOSE to return to Programming screen.



**Table 20: System Options menu**

Function	Default	Description
RF jam detect	Off	Determines whether the panel checks for and reports RF interference/jam to the central station (on), or not (off). If this option is on and the panel receives a constant 319.5 MHz signal, the panel reports the condition to the central station. If this option is off, the panel does not detect an RF jam.
Demo mode	Off	Determines whether the panel operates as a demonstration model (on) or a standard panel (off). Turning on this feature disables low battery supervision. With this option on, the panel is not testing battery supervision.
HW1 function	Interior Siren	Determines how the HW1 I/O output will function: <ul style="list-style-type: none"> <li>• Off = no output</li> <li>• Interior Siren = interior siren output</li> <li>• Armed = output activated when armed</li> <li>• Disarmed = output activated when disarmed</li> <li>• FTC = fail to communicate output, activates when fail to communicate condition occurs (the fail to communicate option must be on)</li> <li>• Alarm = alarm output activated when panel is in alarm</li> <li>• Extior Siren = Extior Siren output</li> </ul>
24-hour clock	Off	Determines whether the panel uses a 24-hour clock (on), or a 12-hour clock (off).

## Siren options

To edit siren options:

1. From the Programming screen, press SIREN OPTIONS.



2. To turn on an option, press . To turn off an option, press . Go to Step 5.  
OR  
Press the white field next to the Voice Chime option to edit.
3. From the Voice chime screen, press  to turn an option on and press  to turn an option off.

**Note:**  indicates the option is turned on.



4. Press SAVE.
5. Press CLOSE to return to the Programming screen.

**Table 21: Siren Options menu**

Function	Default	Description
Panel Piezo beeps	On	Determines whether the panel piezo produces beeps based on system activity (on), or is silent (off).
Panel voice	On	Determines whether the panel announces arming level changes (on), or not (off).
Panel piezo alarm	On	Determines whether the panel piezo emits alarm sounds (on), or not (off).
Trouble beeps	On	Determines whether the panel and hardwired interior sirens sound six beeps every minute when a trouble condition occurs (on), or not (off). The following conditions cause trouble beeps: AC power failure (when AC power failure report is on), low CPU battery, sensor failure (supervisory), sensor trouble (low battery, tamper, etc.), fail to communicate, restoration of power, no activity timer has timed out (trouble beeps continue for 5 minutes and if the panel does not see activity, trouble beeps stop and the panel reports no activity to the central station). You can silence trouble beeps by arming or disarming the system or by pressing the STATUS icon. Trouble beeps resume later if the trouble condition is not cleared.
Voice chime	Off	Determines whether the panel announces the sensor name. <ul style="list-style-type: none"> <li>• Voice Chime = sensor name</li> <li>• Chime Bell = loud ding-dong bell</li> <li>• Soft Chime Bell = soft ding-dong bell</li> <li>• Off = no sound</li> </ul>
HW siren sup	Off	Determines whether the panel monitors hardwired sirens for open conditions (on), or not (off). If this option is turned on, sirens connected to the panel terminals require an EOL resistor in the wire circuit. If this option is turned off, EOL resistors are not required whether sirens are connected or not.
Silent police panic	Off	Determines whether pressing the panel police icon causes an audible (off) or silent (on) alarm.
Alarm report verify	Off	Determines whether the panel verifies successful alarm reports to the central station by displaying "Phone comm OK" (on), or not (off).

## Audio verification options

### To edit audio verification options:

From the Programming screen, press AUDIO VERIFICATION.

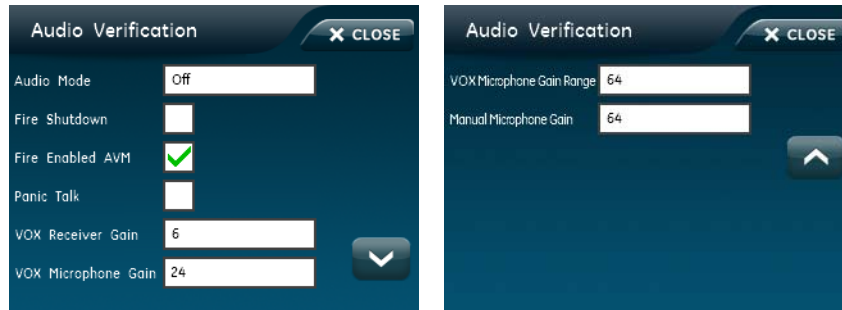

### To edit fire shutdown, fire enabled AVM, and panic talk options:

1. From the Audio Verification screen, press  to turn an option on. Press  to turn an option off.

**Note:**  indicates the option is turned on.

2. Press CLOSE to return to the Programming screen.

### To edit VOX and manual microphone gain options:

1. From the Audio Verification screen, press the white field next to the option.
2. On the keypad, enter the value and press SAVE.
3. Press CLOSE to return to the Programming screen.

### To edit audio mode option:

1. From the Audio Verification screen, press the white field next to audio mode.

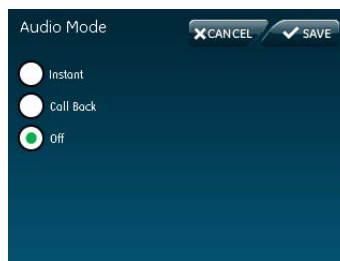

2. From the Audio Mode screen, press  to turn an option on and press  to turn an option off.

**Note:**  indicates the option is turned on.

3. Press SAVE.
4. Press CLOSE to return to the Programming screen.

**Table 22: Audio Verification Options menu**

Function	Default	Description
Audio mode	Off	Determines the audio mode. <ul style="list-style-type: none"> <li>• 1 (Instant)= Panel stays online with central station for an instant audio session.</li> <li>• 2 (Callback) = Panel hangs up and waits for a callback from the central station operator before starting an audio session.</li> <li>• Off = No audio verification.</li> </ul>
Fire shutdown	Off	Determines whether system fire sirens are silenced during a two-way audio session (on), or not (off). Beeps sound every 10 seconds while sirens are silenced.
Fire enabled AVM	On	Turning this option on will enable an AVM session to be initiated following a fire or CO alarm. Turning this option off inhibits the initiation of an AVM session following a fire or CO alarm.
Panic talk	Off	Determines whether the central station operator can talk to the user during a silent alarm (off), or just listen in on the premises (on). Silent alarms occur when sensors in groups 02 or 03 are tripped, when a duress code is entered, or when the panel Police icon is pressed and the silent panel police panic option is turned on.
VOX RX gain	06	Determines the receiver gain level during two-way audio sessions. If the VOX is switching the speaker on when the central station operator is not talking, lower this setting and the VOX mic gain setting. If the VOX is not switching the speaker on when the central station operator is talking, raise this setting and lower the VOX mic gain setting. Changing this setting does not affect speaker volume.
VOX mic gain	24	Determines the mic gain (sensitivity) that triggers the voice-activated switching (VOX). Room size, acoustics, and furnishings where the panel is located will influence the setting. Gain range is 01 (lowest) to 64 (highest).
VOX mic gain rng	64	Determines the gain range for voice-activated switching (VOX). Range is 01 (lowest) to 64 (highest). For best results, this option should be set equal to or greater than VOX mic gain. This option works in conjunction with VOX mic gain. It is important to follow the setting recommendations as described to achieve acceptable operation.
Manual mic gain	64	Determines the gain level (sensitivity) during two-way audio sessions when audio mode is set to 0 or 1 (speak). Room size, acoustics, and furnishings when the panel is located will influence the setting. Gain range is 01 (lowest) to 64 (highest).

## System tests

For more information on system tests see “Testing” on page 57.

**Table 23: System Tests menu**

Function	Default	Description
Sensor test		The sensor test is used to check proper sensor operation.
Comm test		The comm test, or communication test, is used to check proper communication. If Comm Test is not finished it will continue to run even if you exit program mode.
System download		This feature initiates a phone call from the panel to the Enterprise Downloader.

# Testing



This section describes how to test the system.

Before testing the system by generating alarms, contact the central station.

Test the system by pressing the icons as described in Table 24. Table 25 provides a list of the arming levels.

**Note:** An access code is required when arming if the secure arming option is on.

**Table 24: System test sequence**

Icon	Function tested	Test	Correct result
	The panel arms door and window sensors.	Press the DOORS & WINDOWS ONLY (STAY) icon.	Door and window sensors will be armed and the following icon will appear on the home screen: 
	The panel will arm motion sensors.	Press the MOTION SENSORS ONLY (AWAY) icon.	Motion sensors will be armed and the following icon will appear on the home screen: 
   <p>Depending on the arming state of the system, one of the three icons will appear on the screen.</p>	The panel will prompt you to enter an access code. Enter the appropriate code.	Press the appropriate PRESS TO DISARM icon.	The panel will disarm.
Panic Police Fire	Press the EMERGENCY icon on the home screen to access these icons.	Press the appropriate icon to activate a police, fire, or panic emergency alarm.	The panel will sound an alarm and the following alarm icon will appear with the alarm message: 

**Note:** Forty icon presses for invalid codes (ten invalid 4-digit codes, for example) will cause a system access alarm. The alarm locks all touchpads, except key fobs, for 90 seconds.

**Table 25: Arming levels**

Arming level	Description	Indication
1	Disarm the system.	One beep indicates the system is disarmed. The panel displays and speaks Disarmed. The Press to Arm icon appears on the screen (see Table 7 on page 25).
2	Arm doors and windows.	Two beeps verify that door/window sensors are armed. The panel speaks Doors and Windows On. The Press to Disarm Stay icon appears (see Table 7 on page 25).
3	Arm motion sensors.	Three beeps verify that motion sensors are armed. The panel speaks Motions On. The Press to Disarm Away Motions Only icon appears on the screen (see Table 7 on page 25).
4	Arm doors, windows, and motion sensors.	Four beeps verify that door/window and motion sensors are armed. The panel speaks Doors and Windows On, Motion On. The Press to Disarm Away icon appears on the screen (see Table 7 on page 25).

### Arming errors



If you select an arming option on the Arm screen, and there is an arming problem, an arming error message will appear at the bottom of the screen, indicating what the problem is and how to correct it. For example, you might see a message that indicates that you need to close the front door.

Correct the problem as indicated or press Bypass. You will see the arming countdown message at the bottom of the screen. You can press Cancel and enter your code to stop the arming process.

### Sensor test

The sensor test is used to check proper sensor operation.

#### To test the sensors:

1. Place all sensors in their secured (non alarm) state.
2. Access the System Tests screen through the Status & Settings screen by pressing ENTER next to System Tests.
3. Enter the dealer, installer or master code and press OK.
4. Press SENSOR TEST.
5. All learned in sensors will be displayed on this screen. Press   to scroll through the pages.



Test your sensors by tripping them one at a time. The panel will display the number of transmissions received from sensors you trip. See Table 23 on page 56 for specific instructions on how to trip each sensor type.

The panel sounds beeps, and the display identifies the tripped sensor and the number of RF packets received. Each beep represents one RF packet. Count the number of beeps and refer to Table 26 below for minimum requirements. The panel displays Sn (sensor number) Name, and Rounds Detected (# Packets). Scroll through to make sure all sensor have been tested.

**Table 26: Sensor tripping instructions**

Sensor	Instructions	Minimum packets required
Hardwire contact	Open the hardwire contact.	1
Door/window	Open the secured door or window.	6 of 8
Freeze	Remove the sensor cover. Apply ice in a plastic bag to the sensor (for 10 to 15 minutes). Do not allow the sensor to get wet.	6 of 8
Water	Press a wet rag or wet finger over both of the round, gold-plated terminals on the underside of the sensor.	6 of 8
Carbon monoxide alarm	Press and hold the Test/Hush button (approximately 5 seconds) until the unit beeps two times, and then release the button.	6 of 8
Glassbreak	Test with an appropriate glass break sensor tester.	6 of 8
Motion sensor	Avoid the motion sensor field of view for 5 minutes, and then enter its view.	6 of 8
Rate-of-rise heat detector	Rub your hands together until warm, and then place one hand on the detector for 30 seconds.	6 of 8
Shock	Tap the glass twice, away from the sensor. Wait at least 10 seconds before testing again.	6 of 8
Smoke	Press and hold the test button until the system sounds transmission beeps.	6 of 8
Personal help button	Press and hold the appropriate help button until the light blinks and the panel sounds for at least seven beeps.	6 of 8
Key fob	Press and hold the Lock and Unlock buttons simultaneously for 3 seconds.	6 of 8

Sensor	Instructions	Minimum packets required
Simon XT talking touch screen	For sensor testing a 1.0. touch screen, press and hold the Emergency icon for 5 seconds. For sensor testing a 1.1 or greater touch screen, press the Settings (gear) icon, scroll down, and then press the RF Test icon.	6 of 8
Remote touchpad	Press and hold the two Emergency buttons simultaneously for 3 seconds.	6 of 8

6. Press Close repeatedly to exit.

### Sensor Test Failure

If sirens do not beep when a sensor is tripped, use an RF Sniffer (60-401) test tool to verify that the sensor is transmitting. Constant beeps from the RF Sniffer indicate a faulty sensor. Replace the sensor.

If possible, locate sensors within 100 ft. (30 m) of the panel. While a sensor may have a range of 500 ft. (152 m) or more out in the open, the environment at the installation site can have a significant effect on transmitter range. A change in sensor location may help overcome adverse wireless conditions and can potentially be accomplished by the following:

- Reposition the sensor
- Relocate the sensor
- If necessary, replace the sensor

#### To reposition a sensor:

1. Rotate the sensor and test for improved sensor communications at 90 and 180 degrees from original position.
2. If poor communication persists, relocate the sensor.

#### To relocate a sensor:

1. Test the sensor a few inches from the original position.
2. Increase the distance from the original position and retest until an acceptable location is found.
3. Mount the sensor in the new location.
4. If no location is acceptable, replace the sensor.

#### To replace a sensor:

1. Test a known good sensor at the same location.
2. If the transmission beeps remain below the minimum level, avoid mounting a sensor at that location.



3. If the known good sensor functions, contact UTC Fire & Security for repair or replacement of the problem sensor.

### **Sensor Testing Notes:**

- Conduct sensor test in all possible environmental conditions (For example: interior doors open and closed, HVAC system on and off, wireless music system turned on and off).
- Conduct sensor test whenever changes are made to the installation environment that may impact RF performance (For example: mirrors installed, metal backed wallpaper, addition of other RF equipment).
- Sensor testing should be done before and after permanent mounting.

### **Comm Testing**

If Comm Test is not finished it will continue to run even if you exit program mode.

**Note:** Complete panel programming before performing comm testing.

#### **To perform a comm test:**

1. Enter the Status & Settings menu.
2. Scroll until System Tests is listed, Press Enter.
3. Enter the dealer, installer or master code and press OK.
4. Press Comm Test.

The panel displays if the comm test was successful or not.

### **Central station communication**

After performing sensor tests, check that the system is reporting alarms successfully to the central station.

#### **To verify alarm reporting:**

**Note:** The communication with the central station test must be done while NOT in programming mode.

1. Call the central station and tell the operator that you will be testing the system.
2. Arm the system.
3. Test an emergency panic icon and trip at least one sensor of each type (fire, intrusion, etc.) to verify that the appropriate alarms are working correctly. There is a 30 second delay.
4. When you finish testing the system, call the central station to verify that the alarms were received.

## System download

The system download is used to connect the system with the Enterprise Downloader software and complete any tasks programmed into Enterprise Downloader.

### To initiate a system download:

1. Access the System Tests screen through the Status & Settings screen by pressing ENTER next to System Tests.
2. Enter the access code and press OK.
3. Press System Download.

The system will signal when the download is complete.

## Offsite phone operation

Test the system from a remote phone by calling the panel and using the commands in Table 27 below.

### When the panel answers the phone call:

1. Press \* on the phone.
2. Enter master access or user code.

Table 27: Phone commands

System function	Phone command
Disarm	1
Arm doors/windows	2
Arm motion sensors	3
Arm doors/windows with no entry delay	2 2
Arm doors/windows and motion sensors	2 3
Listen in to house	5 to listen in to the house Once in listen in to house the following options are available: <ul style="list-style-type: none"><li>• 0 or 1 to speak</li><li>• 3 or 6 to listen</li><li>• 7 to extend call</li></ul> <b>Note:</b> When in this mode, the user cannot re-enter the previous menu. You must hang up and call back in to the panel to perform additional functions.
Specific light on	*, <unit number>
Specific light off	#, <unit number>
All lights on	* *

System function	Phone command
All lights off	# #
System status	0
Audio verification	5 plus X (X= a command from Audio Verification Set)
Terminate session	9

## Two-way voice operation

### For the central station operator to initiate an audio session:

1. After the panel has completed reporting the alarm, pick up the CS phone and press the \* button to start the audio session.
2. Press 1 or 0 to speak, 2 for VOX operation, and 3 or 6 to listen.
3. Press 99 to terminate the session.

**Note:** Panel voice announcements are silenced during AVM sessions. If the operator does not terminate the session correctly, panel announcements may not occur for up to 90 seconds after the operator hangs up.

**Table 28: Audio verification set**

Phone button	Function
0 or 1	Speak
2	VOX operation
3 or 6	Listen
7	Extend session for 90 more seconds
88	Terminates session with call back (the panel answers on the first ring if called within 5 minutes)
99	Terminates session with no call back

## Voice event notification

Testing this feature requires two people; one at the alarm site and the other at the location the panel is programmed to call.

### To test voice event notification:

1. Contact the central monitoring station (if the system is monitored) to inform them you are testing the system and not to dispatch authorities.
2. At the system site, put the system into an alarm condition.
3. At the calling location, pick up the phone after it starts ringing. You should hear the panel voice announce Press Star for Alarm.

4. Press \* and the panel voice identifies the alarm. If there is more than one alarm in progress, you must press \* for the panel voice to identify them.

After all alarms have been identified, the panel announces Press # to Exit.

5. Press # to terminate the call.

You must terminate the call by pressing #. Otherwise, the panel may not disconnect from the phone line for up to 2 minutes.

## **Cleaning the touch screen**

If necessary, use a soft lint-free cloth to clear smudges on the touch screen; do not use glass cleaner on the touch screen.

## **Disposal**

Dispose of all equipment in accordance with local requirements.

# Troubleshooting

This section provides information to help you diagnose and solve various problems that may arise while configuring or using your Simon XTi.

## System status

To clear Status (alarm memory), from a disarmed state press CLEAR from the Status & Settings screen.

If the panel displays and announces Siren 1 Failure:

- Turn the hardwired siren supervision option off if a hardwired siren or sensor is not connected.
- Check for the correct end-of-line resistor in the HW1 I/O circuit.

If the panel displays and announces Low Battery:

- Check that the panel backup battery is connected.
- Check the panel backup battery voltage. If less than 5.4 volts, replace the battery and clear the system status message.
- Run a sensor test.

If the panel displays and announces RF Jam, the control panel has detected RF interference.

If the panel displays and announces that a sensor is open, see “Sensors” on page 41.

If the display shows Set Time and announces System Time is Not Set, set the system time.

## Control panel

If the panel displays and announces Invalid, the sensor is already programmed. Delete the sensor if not programmed correctly.

If the panel does not beep, turn on the piezo beeps option.

If your screen is not displaying properly, you may need to conduct a screen refresh. Remove the trim ring (**B** in Figure 3 on page 14) and depress the reset key (**D** in Figure 3 on page 14) on the left side of the XTi. Re-install the trim ring.

## Sensors

If a sensor does not work:

- Make sure the battery is good and installed correctly.
- Check for interference from metal objects. Move or rotate the sensor.
- Move the sensor to a new location.

If a door or window is closed, but the panel announces it is open:

- Be certain the arrow on the magnet and the guide line on the transmitter are aligned and within ¼ inch of each other.
- The sensor tamper switch may be open (cover off).

If a motion sensor goes off continuously, be sure the sensor is mounted on a solid surface and the viewing field is free from sources of changing temperature.

If a motion sensor does not respond to motion:

- Make sure the sensor battery is good and installed correctly. Wait 2 minutes after installing a new battery to test the sensor.
- Adjust the sensor mounting.
- Leave the area for 3 minutes, then retest.
- The environment may be too hot or too cold. Outdoor sensors operate between 32 and 120°F (0 and 49°C).
- Dirt or dust may be causing the problem. Wipe the sensor with a clean, damp cloth.

## Specifications

Power	9 VAC, 60 Hz, 25 VA transformer minimum  Rechargeable battery: 6.0 VDC, 2.1 Ah NIMH. Maximum battery charging current is 120 mA. Once the battery reaches a low battery condition, a trouble signal will be annunciated, indicating that the battery may no longer support a full alarm load.  When fully charged, the battery will operate the panel without AC power for 24 hours with the panel in a normal, standby condition, followed by 5 minutes in full alarm condition (including the maximum specified auxiliary load of 250 mA).
Radio frequency	319.5 MHz
Storage temperature	-29 to 140°F (-34 to 60°C) without battery 14 to 86°F (-10 to 30°C) with battery one year shelf life
Operating temperature	32 to 120°F (0 to 49°C)
Maximum humidity	85% relative humidity, noncondensing
Auxiliary power	Unregulated 4.0 to 12.3 VDC, with a maximum of 250 mA

## Sensor names

The following tables provide alphabetical and numerically sequential lists of the sensor name segments.

**Table 29: Alphabetical list of sensor name segments**

190	1st	192	2nd	193	3rd
194	4th	171	Alarm	175	Alert
039	Attic	137	Baby	186	Back
004	Back door	005	Back window	030	Basement
031	Basement window	144	Bathroom	010	Bedroom
011	Bedroom window	140	Boy's	161	Carbon monoxide
014	Child's room	015	Child's room window	038	Closet
160	Delay door	026	Den	027	Den window
168	Detector	129	Dining room	136	Door
034	Downstairs	035	Downstairs window	148	Driveway
183	East	172	Emergency	158	Entry
130	Family room	142	Fire	189	First
196	First floor	195	Floor	166	Freeze sensor
185	Front	002	Front door	003	Front window
028	Garage	006	Garage door	007	Garage window
141	Girl's	164	Glass break	012	Guest room
013	Guest room window	155	Gun	156	Hall
036	Hallway	157	Inside	000	Keychain
159	Keyfob	019	Kitchen	020	Kitchen window
131	Laundry	152	Library	017	Living room
018	Living room window	179	Main	180	Master
008	Master bedroom	009	Master bedroom window	167	Medical
037	Medicine cabinet	041	Module	174	Motion
162	Motion detector	150	Mud room	181	North
151	Nursery	024	Office	025	Office window
147	Outside	173	Panic	133	Patio
023	Patio door	146	Pendant	042	Phone module
176	Police	134	Pool	021	Porch
022	Porch window	187	Rear	139	Room
191	Second	197	Second floor	170	Sensor

153	Shed	149	Shop	188	Side
145	Side door	177	Silent police	132	Sliding door
169	Smoke	163	Smoke detector	182	South
029	Special chime	143	Sun room	040	System panic
198	Third floor	001	Touchpad	138	Toy room
178	Transmitter	032	Upstairs	033	Upstairs window
016	Utility room	165	Water sensor	184	West
135	Window	154	Yard		

**Table 30: Sensor name segments by index number**

000	Keychain	001	Touchpad	002	Front door
003	Front window	004	Back door	005	Back window
006	Garage door	007	Garage window	008	Master bedroom
009	Master bedroom window	010	Bedroom	011	Bedroom window
012	Guest room	013	Guest room window	014	Child's room
015	Child's room window	016	Utility room	017	Living room
018	Living room window	019	Kitchen	020	Kitchen window
021	Porch	022	Porch window	023	Patio door
024	Office	025	Office window	026	Den
027	Den window	028	Garage	029	Special chime
030	Basement	031	Basement window	032	Upstairs
033	Upstairs window	034	Downstairs	035	Downstairs window
036	Hallway	037	Medicine cabinet	038	Closet
039	Attic	040	System panic	041	Module
042	Phone module	043	A	044	B
045	C	046	D	047	E
048	F	049	G	050	H
051	I	052	J	053	K
054	L	055	M	056	N
057	O	058	P	059	Q
060	R	061	S	062	T
063	U	064	V	065	W
066	X	067	Y	068	Z
069	0	070	1	071	2
072	3	073	4	074	5



075	6	076	7	077	8
078	9	079	/	080	\
081	!	082	@	083	#
084	\$	085	%	086	&
087	*	088	(	089	)
090	"	091	-	092	_
093	+	094	=	095	{
096	}	097		098	.
099	<	100	>	101	?
102	(space)	103	a	104	b
105	c	106	d	107	e
108	f	109	g	110	h
111	i	112	j	113	k
114	l	115	m	116	n
117	o	118	p	119	q
120	r	121	s	122	t
123	u	124	v	125	w
126	x	127	y	128	z
129	Dining room	130	Family room	131	Laundry
132	Sliding door	133	Patio	134	Pool
135	Window	136	Door	137	Baby
138	Toy room	139	Room	140	Boy's
141	Girl's	142	Fire	143	Sun room
144	Bathroom	145	Side door	146	Pendant
147	Outside	148	Driveway	149	Shop
150	Mud room	151	Nursery	152	Library
153	Shed	154	Yard	155	Gun
156	Hall	157	Inside	158	Entry
159	Keyfob	160	Delay door	161	Carbon monoxide
162	Motion detector	163	Smoke detector	164	Glass break
165	Water sensor	166	Freeze sensor	167	Medical
168	Detector	169	Smoke	170	Sensor
171	Alarm	172	Emergency	173	Panic
174	Motion	175	Alert	176	Police
177	Silent police	178	Transmitter	179	Main

180	Master	181	North	182	South
183	East	184	West	185	Front
186	Back	187	Rear	188	Side
189	First	190	1st	191	Second
192	2nd	193	3rd	194	4th
195	Floor	196	First floor	197	Second floor
198	Third floor				

# Simon XTi system quick reference

Task	Instructions
Level 1: Disarm the system	Control panel: Press Disarm and enter your access code. Key fob: Press Unlock. Telephone: Press 1.
Level 2: Arm doors and windows	Control panel: Press to Arm, Press Doors & Windows Only and enter your access code (if required). Key fob: Press Lock. Telephone: Press 2.
Level 3: Arm motion sensors	Control panel: Press to Arm, Press Motions Sensors Only and enter your access code (if required). Telephone: Press 3.
Level 4: Arm doors, windows, and motions	Control Panel: Press to Arm, Press Arm All, enter your access code (if required). Key fob: Press Lock twice. Telephone: Press 2 3.
Activate no delay	Control panel: Press to Arm, Press Off next to Entry delay. Key fob: Press Lock. Telephone: Press 2 3.
Activate panic alarm	Control panel: Press Emergency, Press Panic, Police, or Fire. Key fob: Press and hold Lock and Unlock for 3 seconds.
Check system status	Control panel: From the Status & Settings screen, press Listen next to Panel Status. Telephone: Press 0.
Chime on or off	Control panel: From the Status & Settings screen, press On or Off next to Chime.
Specific light on or off	Control panel: From the Status & Settings screen, press Control next to Lights. From the Lights screen, press on/off next to designated light. Key fob: Press * Telephone: Press * <unit num>
All lights on or off	Control panel: From the Status & Settings screen, press Control next to Lights. From the Lights screen, press All On/All Off. Key fob: Press Lights On. Telephone: Press * twice.
Bypass a sensor	Control panel: From the Status & Settings screen, press Select next to Direct Bypass, enter Access Code, press Bypass next to designated sensor.